



IP Office Platform H.323 Telephone Installation

Release 11.1 FP2
Issue 5
October 2022

Notice

While reasonable efforts have been made to ensure that the information in this document is complete and accurate at the time of printing, Avaya assumes no liability for any errors. Avaya reserves the right to make changes and corrections to the information in this document without the obligation to notify any person or organization of such changes.

Documentation disclaimer

"Documentation" means information published in varying mediums which may include product information, operating instructions and performance specifications that are generally made available to users of products. Documentation does not include marketing materials. Avaya shall not be responsible for any modifications, additions, or deletions to the original published version of Documentation unless such modifications, additions, or deletions were performed by or on the express behalf of Avaya. End User agrees to indemnify and hold harmless Avaya, Avaya's agents, servants and employees against all claims, lawsuits, demands and judgments arising out of, or in connection with, subsequent modifications, additions or deletions to this documentation, to the extent made by End User.

Link disclaimer

Avaya is not responsible for the contents or reliability of any linked websites referenced within this site or Documentation provided by Avaya. Avaya is not responsible for the accuracy of any information, statement or content provided on these sites and does not necessarily endorse the products, services, or information described or offered within them. Avaya does not guarantee that these links will work all the time and has no control over the availability of the linked pages.

Warranty

Avaya provides a limited warranty on Avaya hardware and software. Refer to your sales agreement to establish the terms of the limited warranty. In addition, Avaya's standard warranty language, as well as information regarding support for this product while under warranty is available to Avaya customers and other parties through the Avaya Support website: <https://support.avaya.com/helpcenter/getGenericDetails?detailId=C20091120112456651010> under the link "Warranty & Product Lifecycle" or such successor site as designated by Avaya. Please note that if You acquired the product(s) from an authorized Avaya Channel Partner outside of the United States and Canada, the warranty is provided to You by said Avaya Channel Partner and not by Avaya.

"Hosted Service" means an Avaya hosted service subscription that You acquire from either Avaya or an authorized Avaya Channel Partner (as applicable) and which is described further in Hosted SAS or other service description documentation regarding the applicable hosted service. If You purchase a Hosted Service subscription, the foregoing limited warranty may not apply but You may be entitled to support services in connection with the Hosted Service as described further in your service description documents for the applicable Hosted Service. Contact Avaya or Avaya Channel Partner (as applicable) for more information.

Hosted Service

THE FOLLOWING APPLIES ONLY IF YOU PURCHASE AN AVAYA HOSTED SERVICE SUBSCRIPTION FROM AVAYA OR AN AVAYA CHANNEL PARTNER (AS APPLICABLE), THE TERMS OF USE FOR HOSTED SERVICES ARE AVAILABLE ON THE AVAYA WEBSITE, [HTTPS://SUPPORT.AVAYA.COM/LICENSEINFO](https://support.avaya.com/licenseinfo) UNDER THE LINK "Avaya Terms of Use for Hosted Services" OR SUCH SUCCESSOR SITE AS DESIGNATED BY AVAYA, AND ARE APPLICABLE TO ANYONE WHO ACCESSES OR USES THE HOSTED SERVICE. BY ACCESSING OR USING THE HOSTED SERVICE, OR AUTHORIZING OTHERS TO DO SO, YOU, ON BEHALF OF YOURSELF AND THE ENTITY FOR WHOM YOU ARE DOING SO (HEREINAFTER REFERRED TO INTERCHANGEABLY AS "YOU" AND "END USER"), AGREE TO THE TERMS OF USE. IF YOU ARE ACCEPTING THE TERMS OF USE ON BEHALF A COMPANY OR OTHER LEGAL ENTITY, YOU REPRESENT THAT YOU HAVE THE AUTHORITY TO BIND SUCH ENTITY TO THESE TERMS OF USE. IF YOU DO NOT HAVE SUCH AUTHORITY,

OR IF YOU DO NOT WISH TO ACCEPT THESE TERMS OF USE, YOU MUST NOT ACCESS OR USE THE HOSTED SERVICE OR AUTHORIZE ANYONE TO ACCESS OR USE THE HOSTED SERVICE.

Licenses

THE SOFTWARE LICENSE TERMS AVAILABLE ON THE AVAYA WEBSITE, [HTTPS://SUPPORT.AVAYA.COM/LICENSEINFO](https://support.avaya.com/licenseinfo), UNDER THE LINK "AVAYA SOFTWARE LICENSE TERMS (Avaya Products)" OR SUCH SUCCESSOR SITE AS DESIGNATED BY AVAYA, ARE APPLICABLE TO ANYONE WHO DOWNLOADS, USES AND/OR INSTALLS AVAYA SOFTWARE, PURCHASED FROM AVAYA INC., ANY AVAYA AFFILIATE, OR AN AVAYA CHANNEL PARTNER (AS APPLICABLE) UNDER A COMMERCIAL AGREEMENT WITH AVAYA OR AN AVAYA CHANNEL PARTNER. UNLESS OTHERWISE AGREED TO BY AVAYA IN WRITING, AVAYA DOES NOT EXTEND THIS LICENSE IF THE SOFTWARE WAS OBTAINED FROM ANYONE OTHER THAN AVAYA, AN AVAYA AFFILIATE OR AN AVAYA CHANNEL PARTNER; AVAYA RESERVES THE RIGHT TO TAKE LEGAL ACTION AGAINST YOU AND ANYONE ELSE USING OR SELLING THE SOFTWARE WITHOUT A LICENSE. BY INSTALLING, DOWNLOADING OR USING THE SOFTWARE, OR AUTHORIZING OTHERS TO DO SO, YOU, ON BEHALF OF YOURSELF AND THE ENTITY FOR WHOM YOU ARE INSTALLING, DOWNLOADING OR USING THE SOFTWARE (HEREINAFTER REFERRED TO INTERCHANGEABLY AS "YOU" AND "END USER"), AGREE TO THESE TERMS AND CONDITIONS AND CREATE A BINDING CONTRACT BETWEEN YOU AND AVAYA INC. OR THE APPLICABLE AVAYA AFFILIATE ("AVAYA").

Avaya grants You a license within the scope of the license types described below, with the exception of Heritage Nortel Software, for which the scope of the license is detailed below. Where the order documentation does not expressly identify a license type, the applicable license will be a Designated System License as set forth below in the Designated System(s) License (DS) section as applicable. The applicable number of licenses and units of capacity for which the license is granted will be one (1), unless a different number of licenses or units of capacity is specified in the documentation or other materials available to You. "Software" means computer programs in object code, provided by Avaya or an Avaya Channel Partner, whether as stand-alone products, pre-installed on hardware products, and any upgrades, updates, patches, bug fixes, or modified versions thereto. "Designated Processor" means a single stand-alone computing device. "Server" means a set of Designated Processors that hosts (physically or virtually) a software application to be accessed by multiple users. "Instance" means a single copy of the Software executing at a particular time: (i) on one physical machine; or (ii) on one deployed software virtual machine ("VM") or similar deployment.

License type(s)

Designated System(s) License (DS). End User may install and use each copy or an Instance of the Software only: 1) on a number of Designated Processors up to the number indicated in the order; or 2) up to the number of Instances of the Software as indicated in the order, Documentation, or as authorized by Avaya in writing. Avaya may require the Designated Processor(s) to be identified in the order by type, serial number, feature key, Instance, location or other specific designation, or to be provided by End User to Avaya through electronic means established by Avaya specifically for this purpose.

Concurrent User License (CU). End User may install and use the Software on multiple Designated Processors or one or more Servers, so long as only the licensed number of Units are accessing and using the Software at any given time as indicated in the order, Documentation, or as authorized by Avaya in writing. A "Unit" means the unit on which Avaya, at its sole discretion, bases the pricing of its licenses and can be, without limitation, an agent, port or user, an e-mail or voice mail account in the name of a person or corporate function (e.g., webmaster or helpdesk), or a directory entry in the administrative database utilized by the Software that permits one user to interface with the Software. Units may be linked to a specific, identified Server or an Instance of the Software.

Cluster License (CL). End User may install and use each copy or an Instance of the Software only up to the number of Clusters as

indicated on the order, Documentation, or as authorized by Avaya in writing with a default of one (1) Cluster if not stated.

Enterprise License (EN). End User may install and use each copy or an Instance of the Software only for enterprise-wide use of an unlimited number of Instances of the Software as indicated on the order, Documentation, or as authorized by Avaya in writing.

Named User License (NU). End User may: (i) install and use each copy or Instance of the Software on a single Designated Processor or Server per authorized Named User (defined below); or (ii) install and use each copy or Instance of the Software on a Server so long as only authorized Named Users access and use the Software as indicated in the order, Documentation, or as authorized by Avaya in writing. "Named User", means a user or device that has been expressly authorized by Avaya to access and use the Software. At Avaya's sole discretion, a "Named User" may be, without limitation, designated by name, corporate function (e.g., webmaster or helpdesk), an e-mail or voice mail account in the name of a person or corporate function, or a directory entry in the administrative database utilized by the Software that permits one user to interface with the Software.

Shrinkwrap License (SR). End User may install and use the Software in accordance with the terms and conditions of the applicable license agreements, such as "shrinkwrap" or "clickthrough" license accompanying or applicable to the Software ("Shrinkwrap License") as indicated in the order, Documentation, or as authorized by Avaya in writing.

Transaction License (TR). End User may use the Software up to the number of Transactions as specified during a specified time period and as indicated in the order, Documentation, or as authorized by Avaya in writing. A "Transaction" means the unit by which Avaya, at its sole discretion, bases the pricing of its licensing and can be, without limitation, measured by the usage, access, interaction (between client/server or customer/organization), or operation of the Software within a specified time period (e.g. per hour, per day, per month). Some examples of Transactions include but are not limited to each greeting played/message waiting enabled, each personalized promotion (in any channel), each callback operation, each live agent or web chat session, each call routed or redirected (in any channel). End User may not exceed the number of Transactions without Avaya's prior consent and payment of an additional fee.

Heritage Nortel Software

"Heritage Nortel Software" means the software that was acquired by Avaya as part of its purchase of the Nortel Enterprise Solutions Business in December 2009. The Heritage Nortel Software is the software contained within the list of Heritage Nortel Products located at <https://support.avaya.com/LicenseInfo> under the link "Heritage Nortel Products" or such successor site as designated by Avaya. For Heritage Nortel Software, Avaya grants Customer a license to use Heritage Nortel Software provided hereunder solely to the extent of the authorized activation or authorized usage level, solely for the purpose specified in the Documentation, and solely as embedded in, for execution on, or for communication with Avaya equipment. Charges for Heritage Nortel Software may be based on extent of activation or use authorized as specified in an order or invoice.

Copyright

Except where expressly stated otherwise, no use should be made of materials on this site, the Documentation, Software, Hosted Service, or hardware provided by Avaya. All content on this site, the documentation, Hosted Service, and the product provided by Avaya including the selection, arrangement and design of the content is owned either by Avaya or its licensors and is protected by copyright and other intellectual property laws including the sui generis rights relating to the protection of databases. You may not modify, copy, reproduce, republish, upload, post, transmit or distribute in any way any content, in whole or in part, including any code and software unless expressly authorized by Avaya. Unauthorized reproduction, transmission, dissemination, storage, and or use without the express written consent of Avaya can be a criminal, as well as a civil offense under the applicable law.

Virtualization

The following applies if the product is deployed on a virtual machine. Each product has its own ordering code and license types. Unless otherwise stated, each Instance of a product must be separately

licensed and ordered. For example, if the end user customer or Avaya Channel Partner would like to install two Instances of the same type of products, then two products of that type must be ordered.

Third Party Components

"Third Party Components" mean certain software programs or portions thereof included in the Software or Hosted Service may contain software (including open source software) distributed under third party agreements ("Third Party Components"), which contain terms regarding the rights to use certain portions of the Software ("Third Party Terms"). As required, information regarding distributed Linux OS source code (for those products that have distributed Linux OS source code) and identifying the copyright holders of the Third Party Components and the Third Party Terms that apply is available in the products, Documentation or on Avaya's website at: <https://support.avaya.com/Copyright> or such successor site as designated by Avaya. The open source software license terms provided as Third Party Terms are consistent with the license rights granted in these Software License Terms, and may contain additional rights benefiting You, such as modification and distribution of the open source software. The Third Party Terms shall take precedence over these Software License Terms, solely with respect to the applicable Third Party Components to the extent that these Software License Terms impose greater restrictions on You than the applicable Third Party Terms.

The following applies only if the H.264 (AVC) codec is distributed with the product. THIS PRODUCT IS LICENSED UNDER THE AVC PATENT PORTFOLIO LICENSE FOR THE PERSONAL USE OF A CONSUMER OR OTHER USES IN WHICH IT DOES NOT RECEIVE REMUNERATION TO (i) ENCODE VIDEO IN COMPLIANCE WITH THE AVC STANDARD ("AVC VIDEO") AND/OR (ii) DECODE AVC VIDEO THAT WAS ENCODED BY A CONSUMER ENGAGED IN A PERSONAL ACTIVITY AND/OR WAS OBTAINED FROM A VIDEO PROVIDER LICENSED TO PROVIDE AVC VIDEO. NO LICENSE IS GRANTED OR SHALL BE IMPLIED FOR ANY OTHER USE. ADDITIONAL INFORMATION MAY BE OBTAINED FROM MPEG LA, L.L.C. SEE [HTTP://WWW.MPEGLA.COM](http://www.mpegla.com).

Service Provider

THE FOLLOWING APPLIES TO AVAYA CHANNEL PARTNER'S HOSTING OF AVAYA PRODUCTS OR SERVICES. THE PRODUCT OR HOSTED SERVICE MAY USE THIRD PARTY COMPONENTS SUBJECT TO THIRD PARTY TERMS AND REQUIRE A SERVICE PROVIDER TO BE INDEPENDENTLY LICENSED DIRECTLY FROM THE THIRD PARTY SUPPLIER. AN AVAYA CHANNEL PARTNER'S HOSTING OF AVAYA PRODUCTS MUST BE AUTHORIZED IN WRITING BY AVAYA AND IF THOSE HOSTED PRODUCTS USE OR EMBED CERTAIN THIRD PARTY SOFTWARE, INCLUDING BUT NOT LIMITED TO MICROSOFT SOFTWARE OR CODECS, THE AVAYA CHANNEL PARTNER IS REQUIRED TO INDEPENDENTLY OBTAIN ANY APPLICABLE LICENSE AGREEMENTS, AT THE AVAYA CHANNEL PARTNER'S EXPENSE, DIRECTLY FROM THE APPLICABLE THIRD PARTY SUPPLIER.

WITH RESPECT TO CODECS, IF THE AVAYA CHANNEL PARTNER IS HOSTING ANY PRODUCTS THAT USE OR EMBED THE H.264 CODEC OR H.265 CODEC, THE AVAYA CHANNEL PARTNER ACKNOWLEDGES AND AGREES THE AVAYA CHANNEL PARTNER IS RESPONSIBLE FOR ANY AND ALL RELATED FEES AND/OR ROYALTIES. THE H.264 (AVC) CODEC IS LICENSED UNDER THE AVC PATENT PORTFOLIO LICENSE FOR THE PERSONAL USE OF A CONSUMER OR OTHER USES IN WHICH IT DOES NOT RECEIVE REMUNERATION TO: (I) ENCODE VIDEO IN COMPLIANCE WITH THE AVC STANDARD ("AVC VIDEO") AND/OR (II) DECODE AVC VIDEO THAT WAS ENCODED BY A CONSUMER ENGAGED IN A PERSONAL ACTIVITY AND/OR WAS OBTAINED FROM A VIDEO PROVIDER LICENSED TO PROVIDE AVC VIDEO. NO LICENSE IS GRANTED OR SHALL BE IMPLIED FOR ANY OTHER USE. ADDITIONAL INFORMATION FOR H.264 (AVC) AND H.265 (HEVC) CODECS MAY BE OBTAINED FROM MPEG LA, L.L.C. SEE [HTTP://WWW.MPEGLA.COM](http://www.mpegla.com).

Compliance with Laws

You acknowledge and agree that it is Your responsibility for complying with any applicable laws and regulations, including, but not

limited to laws and regulations related to call recording, data privacy, intellectual property, trade secret, fraud, and music performance rights, in the country or territory where the Avaya product is used.

Preventing Toll Fraud

“Toll Fraud” is the unauthorized use of your telecommunications system by an unauthorized party (for example, a person who is not a corporate employee, agent, subcontractor, or is not working on your company's behalf). Be aware that there can be a risk of Toll Fraud associated with your system and that, if Toll Fraud occurs, it can result in substantial additional charges for your telecommunications services.

Avaya Toll Fraud intervention

If You suspect that You are being victimized by Toll Fraud and You need technical assistance or support, call Technical Service Center Toll Fraud Intervention Hotline at +1-800-643-2353 for the United States and Canada. For additional support telephone numbers, see the Avaya Support website: <https://support.avaya.com> or such successor site as designated by Avaya.

Security Vulnerabilities

Information about Avaya's security support policies can be found in the Security Policies and Support section of <https://support.avaya.com/security>.

Suspected Avaya product security vulnerabilities are handled per the Avaya Product Security Support Flow (<https://support.avaya.com/css/P8/documents/100161515>).

Trademarks

The trademarks, logos and service marks (“Marks”) displayed in this site, the Documentation, Hosted Service(s), and product(s) provided by Avaya are the registered or unregistered Marks of Avaya, its affiliates, its licensors, its suppliers, or other third parties. Users are not permitted to use such Marks without prior written consent from Avaya or such third party which may own the Mark. Nothing contained in this site, the Documentation, Hosted Service(s) and product(s) should be construed as granting, by implication, estoppel, or otherwise, any license or right in and to the Marks without the express written permission of Avaya or the applicable third party.

Avaya is a registered trademark of Avaya Inc.

All non-Avaya trademarks are the property of their respective owners.

Linux® is the registered trademark of Linus Torvalds in the U.S. and other countries.

Contents

Part 1: IP Office H323 Phone Installation	9
Chapter 1: IP Office H.323 IP Phones	10
Supported H.323 IP Phones.....	11
System Capacity.....	12
Phone Firmware.....	12
File Auto-Generation.....	14
Simple Installation.....	14
Installation Requirements.....	15
Licenses and Subscriptions.....	17
Network Assessment.....	17
Voice Compression Channels.....	18
QoS.....	20
Potential VoIP Problems.....	20
User PC Connection.....	21
Power Supply Options.....	22
File Server Options.....	23
Control Unit Memory Cards.....	24
Phone File Requests.....	25
File Auto-Generation.....	25
Control unit memory card.....	26
Registration Blacklisting.....	26
Blocking Default Passcodes.....	27
Chapter 2: Additional Phone Settings	28
46xxspecials.txt.....	29
NoUser Source Numbers.....	30
Configuring and editing file settings.....	30
Part 2: Basic Installation Process	32
H.323 IP Phone Installation.....	32
Chapter 3: Licenses and Subscriptions	34
Reserving Licenses.....	34
Chapter 4: Enabling the H.323 Gatekeeper	36
Setting the RTP Port Range.....	36
Adjusting DiffServ QoS.....	38
System Default Codecs.....	38
Chapter 5: DHCP Settings	40
System DHCP Support.....	40
System Site Specific Option Numbers.....	41
Changing the system's SSON settings.....	41

Chapter 6: File Server Settings	43
Changing the file server settings.....	44
Phone File Server Settings.....	45
Creating/Editing the Settings File.....	45
Manually Editing the File.....	47
Loading Software Files onto the System.....	47
IP500 V2 Control Unit.....	48
Using Embedded File Manager to Check/Upload Files.....	48
Manually Copying Files.....	49
Loading Files onto a third Party Server.....	50
Chapter 7: User and Extension Creation	51
Default Extension Password.....	51
Manually Creating Users.....	52
Manually Creating Extensions.....	52
Selecting the required codec.....	53
Using Auto-Creation.....	54
Chapter 8: Connecting the phone	55
Registering phone.....	56
Listing Registered Phones.....	57
Part 3: Optional Configuration	58
Chapter 9: Enabling RTCP Quality Monitoring	59
Enabling Telephone Quality Reporting.....	59
Enabling System Quality Reporting.....	60
Setting the Quality Alarm Levels.....	61
Chapter 10: Screensaver	62
Customizing screen saver settings.....	63
Chapter 11: Backup/Restore Settings	64
Specifying the BRURI Value.....	65
HTTP Authentication.....	65
Manual Backup/Restore Control.....	66
Example File.....	66
Configuring IIS server.....	67
Configuring apache server.....	68
Part 4: Advanced Installation Processes	69
Chapter 12: Static Address Installation	70
Installing static address for 1600 series phones.....	70
Static address installation settings for 1600 phone series.....	71
Installing static address for 9600 series phones.....	71
Static address installation settings for 9600 phone series.....	72
Chapter 13: Remote H.323 Extensions	73
Customer Network Configuration.....	74

Configuring IP Office System.....	75
Phone Configuration.....	76
Chapter 14: VPN Remote Phones.....	77
Installation Documentation.....	78
Supported VPN remote Phone Firmware.....	78
Configuring the IP Phone for VPN remote.....	79
VLAN and IP Phones.....	79
VLAN and DHCP.....	80
Example setup - Overview.....	81
Example System Overview.....	84
Chapter 15: Alternate DHCP Server Setup.....	86
Alternate Options.....	86
Checking for DHCP Server Support.....	88
Creating a Scope.....	88
Adding a 242 option.....	90
Activating the Scope.....	91
Chapter 16: SRTP Support.....	92
Enable System SRTP.....	92
Enabling system SRTP.....	93
Disabling SRTP on an extension or line.....	93
Direct media.....	94
Chapter 17: TLS Support.....	95
Changing the CRAFT Password.....	96
Adding the Identity Certificate.....	96
Downloading the identity certificate from a Linux based server.....	97
Uploading a certificate to the server's trusted certificate store.....	97
Enabling TLS on the IP Office.....	98
Enabling TLS on the telephone.....	98
Checking TLS Operation.....	99
Part 5: Miscellaneous.....	100
Chapter 18: Static Administration Options.....	101
Using Static Administration Options.....	101
Entering administrative options in 1600 series phones.....	102
Entering administrative options in 9600 series phones.....	102
Administrator Process Password.....	103
Enabling hub interface.....	103
Enabling hub interface for 1600 series phones.....	104
Enabling hub interface for 9600 series.....	104
View details of phone.....	104
View details of 1600 series phones.....	105
Viewing details of 9600 series phones.....	106
Self-test procedure for 1600 series phones.....	106

- Self-test procedure for 9600 series phones..... 107
- Resetting a phone..... 107
 - Resetting 1600 series phone..... 108
 - Resetting 9600 series phone..... 108
- Clearing a Phone..... 109
 - Clearing 1600 series phones..... 109
 - Clearing 9600 series phones..... 109
- Site Specific Option Number..... 110
 - SSON in 1600 series phones..... 110
 - SSON in 9600 phone series..... 111
- Chapter 19: Restart Senarios**..... 112
 - Boot File Needs Upgrading..... 113
 - No Application File or Application File Needs Upgrading..... 113
 - Correct Boot File and Application File Already Loaded..... 114
- Part 6: Further Help**..... 115
 - Chapter 20: Additional Help and Documentation**..... 116
 - Additional Manuals and User Guides..... 116
 - Getting Help..... 116
 - Finding an Avaya Business Partner..... 117
 - Additional IP Office resources..... 117
 - Training..... 118

Part 1: IP Office H323 Phone Installation

Chapter 1: IP Office H.323 IP Phones

This documentation provides notes for the installation of supported Avaya IP phones onto an IP Office system. It should be used in conjunction with the existing installation documentation for those series of phones.

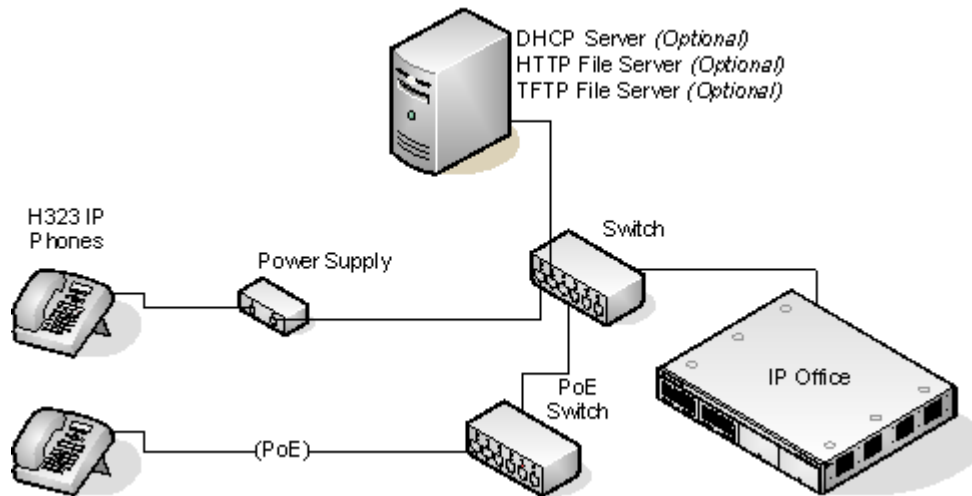

- **DHCP versus Static IP Installation:** Though static IP installation of H.323 IP phones is possible, installation using DHCP is strongly recommended. The use of DHCP eases both the installation process and future maintenance and administration. For static installations, following a boot file upgrade, all static address settings are lost and must be re-entered.
- **Network Assessment:** High quality voice transmission across an IP network requires careful assessment of many factors. Therefore:
 - We strongly recommend that IP phone installation is only done by installers with VoIP experience.
 - The whole customer network must be assessed for its suitability for VoIP, before installation. Avaya will not support any installation where the results of a network assessment cannot be supplied. See [Network Assessment](#) on page 17 for further details.

Related links

[Supported H.323 IP Phones](#) on page 11

[System Capacity](#) on page 12

[Phone Firmware](#) on page 12

[File Auto-Generation](#) on page 14

[Simple Installation](#) on page 14

- [Installation Requirements](#) on page 15
- [Licenses and Subscriptions](#) on page 17
- [Network Assessment](#) on page 17
- [Voice Compression Channels](#) on page 18
- [QoS](#) on page 20
- [Potential VoIP Problems](#) on page 20
- [User PC Connection](#) on page 21
- [Power Supply Options](#) on page 22
- [File Server Options](#) on page 23
- [Control Unit Memory Cards](#) on page 24
- [Phone File Requests](#) on page 25
- [Control unit memory card](#) on page 26
- [Registration Blacklisting](#) on page 26
- [Blocking Default Passcodes](#) on page 27

Supported H.323 IP Phones

This documentation provides installation notes for the following Avaya phones. Other supported Avaya H.323 IP phones, for example DECT R4 3700 Series phones are covered by separate installation documentation.

H.323 IP Phones		PoE Class		PC Port	Subscription Mode
		Class	Idle		
1600 Series	1603	2	4.4W	-	✓
	1603SW	2	4.4W	✓	✓
	1608	2	3.7W	✓	✓
	1616	2	2.7W	✓	✓
9600 Series	9608	1	2.08W	✓	✓
	9611G	1	2.8W	✓	✓
	9621G	2	3.49W	✓	✓
	9641G	2	3.44W	✓	✓

- 1603/1603SW - These phones require a PoE Splitter unit in order to use PoE.

Related links

- [IP Office H.323 IP Phones](#) on page 10

System Capacity

System capacity encompasses the number of configurable phone extensions and the number of simultaneous IP phone calls.

Extension Capacity

The maximum number of H.323 IP phones supported depends on the type of system.

IP500 V2 systems support up to 384 extensions. To find the capacity for IP phones subtract the number of physical non-IP extensions ports in the system, ie. extension ports on the IP Office control unit and any external expansion modules. Note however that these systems only support a maximum of 148 VCM channels which may also restrict the number of simultaneous VoIP calls, see below.

For IP Office Server Edition systems, the IP extension capacity depends on the server type. Refer to the [Avaya IP Office™ Platform Guidelines: Capacity](#) document.

Call Capacity

There are a number of situations where the IP500 V2 system needs to provide a voice compression channel in order for an IP phone to make calls. These channels are provided by Voice Compression Modules (VCMs) installed in the system. The number of VCM channels required and how long the channel is required depends on a number of factors.

A simple summary is:

- A VCM channel is required during call setup.
- The VCM channel is released if the call is to/from another IP device using the same compression codec (the supported VCM codecs are G.711, G.729 and G.722).
- The VCM channel is used for the duration of the call when the call is to/from/via a non-IP device (extension or trunk line).
- It should be remembered that VCM channels are also used for calls from non-IP devices to IP lines if those are configured in the IP Office system (IP, SIP and SES lines).
- Calls from IP phones to the IP Office voicemail server use a VCM channel.

Related links

[IP Office H.323 IP Phones](#) on page 10

Phone Firmware

The firmware used by Avaya IP phones is upgradeable and different releases of firmware are made available via the Avaya support website. However, H.323 IP phones used on a IP Office system must only use the firmware supplied pre-installed with the IP Office system or with its IP Office Manager application. Other versions of IP Phone firmware may not have been tested specifically with IP Office systems and so should not be used unless IP Office support is specifically mentioned in the firmware's accompanying documentation.

The firmware consists of a number of different types of files:

File Type	Description
xxupgrade files	<p>The first file that a phone requests when starting up is the <code>xxupgrade</code> file. This file contains a list of the phone <code>.bin</code> files that are available as part of the firmware set and the version numbers of those files. If the version of a file differs from that which the phone already has loaded, the phone will request the new file.</p> <p>During this process the phone may reboot after loading each file and then request the <code>xxupgrade.txt</code> file again until it has updated all its firmware, if necessary. Separate files are provided for the different phone series. For example:</p> <ul style="list-style-type: none"> • <code>16xxupgrade.txt</code>: This file lists the firmware files that 1600 Series phones should load. • <code>96xxupgrade.txt</code>: This file lists the firmware files that 9600 Series phones should load. • <code>96x1Hupgrade.txt</code>: This file list the firmware files that 9608, 9611, 9621, and 9641 phones should load.
<code>.bin</code> files	Following the instructions in the <code>xxupgrade.txt</code> file, the phone will load any <code>.bin</code> files it requires if their versions differ from that which the phone already has loaded.
<code>.tar</code> files	Instead of the <code>.bin</code> file used by other phones, the 9600 Series phones use <code>.tar</code> archive files to download multiple files in a single step and then unpack the <code>.tar</code> files to load their contents.
<code>46xxsettings.txt</code> files	The last line of the <code>xxupgrade.txt</code> file instructs the phone to load a <code>46xxsettings.txt</code> file. This is an editable file which can be used to adjust the operation of the phones.
<code>.lng</code> files	The firmware may include language files for use by 1600 Series and 9600 Series phones. Which of these language files are loaded is set in the <code>46xxsettings.txt</code> file.

The phone firmware files are installed as part of the IP Office Manager application and are found in the application's installation directory. By default, the directory is found at `c:\Program Files\Avaya\IP Office\Manager`.

The same firmware files can also be obtained directly from the software package used to install IP Office Manager without having to perform the installation. The files are located in the `\program files\Avaya\IPOffice\Manager` sub-folder of the installation directory.

Note that these sets of files include `.bin` files that are also used for other devices including the IP Office system itself.

Related links

[IP Office H.323 IP Phones](#) on page 10

File Auto-Generation

When the IP Office system is acting as the file server for the phones, it is able to auto-generate the `46xxsettings.txt` and `.lng` files used by the phones. It will do this if the requested file is not physically present in the location where the system stores the firmware files. The system also uses the user's configuration settings to auto-generate the phone user settings file.

The system still auto-generates files even when HTTP redirection is used to load the 9608, 9611, 9621, and 9641 `.bin` files from another file server.

Related links

[IP Office H.323 IP Phones](#) on page 10

Simple Installation

The simplest installation has the IP Office system acting as the DHCP and file servers for all the IP phones registered with it.

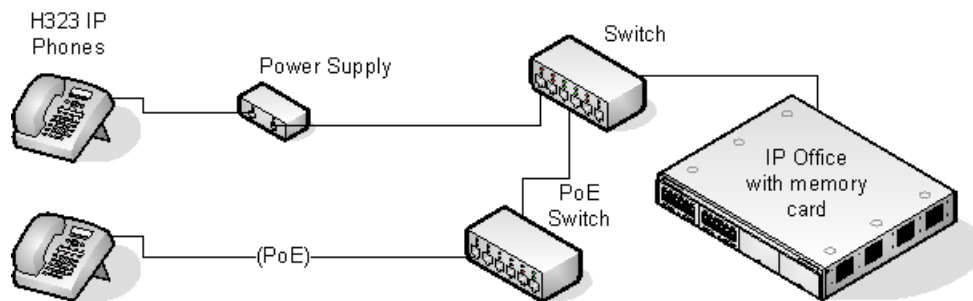

This type of installation uses the following equipment:

- **IP Office Server:** The IP Office system performs a number of roles for the phones:
 - **DHCP Server:** The IP Office system is acting as the DHCP server for the phones. The DHCP response to the phones includes both IP address settings, details of the file server to use as configured in the IP Office configuration and the systems on address as the H.323 gatekeeper for the phones. The IP Office DHCP function can be configured to provide DHCP addresses only in response to requests from Avaya IP phones. This allows an alternate DHCP server to be used for other devices that use DHCP.
 - **H.323 Gatekeeper:** IP phones require an H.323 gatekeeper to which they register. The gatekeeper then controls the connection of calls to and from the phone. In this and all scenarios the IP Office systems as the H.323 Gatekeeper.
 - **File Server:** During installation the IP phones need to download firmware files from a file server. This is done using either HTTPS, HTTP or TFTP in that order (1600 and 9600 Series phones do not support TFTP). The IP Office control unit memory card can be used as the file source.

- IP500 V2 systems can act as the file server for up to 50 phones by using their own memory card. IP Office Server Edition systems can also act as the file server for up to 50 phones. For larger numbers a separate 3rd-party HTTP server should be used.
- **Backup/Restore Server:** 1600 Series and 9600 Series phones can be configured to backup and restore user and phone settings to a server. The address of this server is set separately from that of the file server used for phone firmware though the same server may be useable. The recommended method is to use the IP Office system as the server for this function.
- **Switches:** The IP Office has a limited number of LAN connection ports, intended only to connect itself to the existing data network. The addition of IP phones will require the network to include additional port capacity.
- **Power Supplies:** Each H.323 IP phone requires a power supply. The IP Office system does not provide any power to IP phones. The phones can be:
 - **Power over Ethernet Supply:** Most Avaya IP phones can be powered from an 802.3af Power over Ethernet (PoE) power supply. This can be done using PoE switches to support multiple phones or using individual PoE injector devices for each phone.
 - **Individual Power Supply Units:** An individual power supply unit can be used with each phone. This requires a power supply socket at each phone location. The type of power supply will depend on the type of phone. Note that phones using button modules may need to use an individual power supply unit rather than PoE.

Related links

[IP Office H.323 IP Phones](#) on page 10

Installation Requirements

To install an IP phone on IP Office, the following items are required:

	Description
Network Assessment	A network assessment must be completed. Avaya will not support VoIP on a network where a satisfactory network assessment has not been obtained.
Extension Number and User Details	A full listing of the planned extension number and user name details is required. The planned extension number must be unused and is requested by the phone during installation.
Power Supplies	Each phone requires a power supply. Avaya IP phones do not draw power from the IP Office. A number of options exist for how power is supplied to the phones and all the Avaya IP deskphones support Power over Ethernet (PoE). See Power Supply Options on page 22
LAN Socket	An RJ45 Ethernet LAN connection point is required for each phone.

Table continues...

	Description
Category 5 Cabling	All LAN cables and LAN cable infrastructure used with H.323 IP phones should use CAT5 cabling.
LAN Cables	<p>Check that an RJ45 LAN cable has been supplied with the IP phone for connection to the power supply unit. You may also need an additional RJ45 LAN cable for connection from the power unit to the customer LAN. This will depend on the type of power supply being used.</p> <p>A further RJ45 LAN cable can be used to connect the user's PC to the LAN via the IP phone (not supported on 4601, 4602, 5601 and 5602 H.323 IP phones).</p>
Voice Compression Channels	For IP500 V2 systems, the control unit must have voice compression channels installed. Channels are required during the connection if calls involving IP phones and may also be required during the call. See Voice Compression Channels on page 18 for full details.
DHCP Server	<p>The IP Office Unit can perform this role for all the phones. If another DHCP server is used for the network, this may be able to do DHCP for the H.323 IP phones, see Alternate DHCP Servers . Also the IP Office system can be configured to only provide DHCP support to Avaya IP phones.</p> <ul style="list-style-type: none"> • Static IP addressing can also be used for IP phone installation if required. However that method of installation is not recommended.
HTTP File Server	A PC running the IP Office Manager application can perform this role for up to 5 H.323 IP phones. An IP Office control unit with a memory card can use that memory card as the source for up to 50 phones. The IP Office system can act as the file server for up to 50 IP phones. For larger numbers a separate 3rd-party HTTP server should be used.
H.323 Gatekeeper	The IP Office system performs this role.
Manager PC	A Windows PC running IP Office Manager is required for IP Office configuration changes. The PC should also have System Status Application and System Monitor installed.
IP Telephone Software	The software for IP phone installation is installed into the IP Office Manager application's program folder as during the applications installation. It is also included as part of the IP Office Server Edition applications installation of the IP Office application on the server.
Licenses and Subscriptions	For systems not running in subscription mode, each IP phones registered with the system requires an license to operate. On subscriptions mode systems, the extension must be associated with a subscribed user. Refer to Licenses and Subscriptions
Backup/Restore Server	The phones backup and restore various phone and user settings whenever the user logs on or logs out. This uses files stored on a file server. This is not necessarily the same server as used for the phone firmware files. The IP Office system's own file storage can be used for this function and is the recommended option.

Related links

[IP Office H.323 IP Phones](#) on page 10

Licenses and Subscriptions

Subscriptions

Systems running in subscription mode support extensions up to the total number of user subscriptions available.

Licenses

For systems not running in subscription mode, licenses are required for each IP extension.

- On IP Office Server Edition systems, the user must be configured to a licensed user profile with a user license such as the Basic User license. Unlicensed users cannot login to an extension.
- For Avaya phones, an Avaya IP Endpoint license is required for each phone. This includes all 1600, 9600, IP DECT, DECT R4 and Spectralink.
- For non-Avaya IP phones, a Third-Party IP Endpoint license is required.
 - By default licenses are consumed by each Avaya IP phone that registers with the IP Office in the order that they register. The license is released if the phone unregisters. However, it is possible to reserve a license for particular phones in order to ensure that they phones always obtain a license. This is done through the **Reserve Avaya IP Endpoint License** setting of each IP extension. On system's using WebLM licensing, this option is fixed to reserve a license.
 - Avaya IP phones without a license are still be able to register but are limited to making emergency calls only (Dial Emergency short code calls). The associated user is treated as if logged off and the phone displays "No license available". If a license becomes available, it is assigned to any unlicensed DECT handsets first and then to any other unlicensed Avaya phones in the order that the phones registered.

Related links

[IP Office H.323 IP Phones](#) on page 10

[Reserving Licenses](#) on page 34

Network Assessment

The IP Office system is a pure Voice over IP (VoIP) system. All trunks and telephone extensions connect to the system via the customers data network. It is therefore absolutely imperative that the customer network is assessed and reconfigured if necessary to meet the needs of VoIP traffic.

Warning:

When installing IP phones on a IP Office system, it is assumed by Avaya that a network assessment has been performed. If a support issue is escalated to Avaya, Avaya may request to see the results of a recent network assessment and may refuse to provide support if a network assessment with satisfactory results has not been performed.

Current technology allows optimally configured networks to deliver VoIP services with voice quality that matches that of the public phone network. However, few networks are optimally configured and so care should be taken to assess the VoIP quality achievable within a customer network.

Not every network is able to carry voice transmissions. Some data networks have insufficient capacity for voice traffic or have data peaks that will occasionally impact voice traffic. In addition, the usual history of growing and developing a network by integrating products from many vendors makes it necessary to test all the network components for compatibility with VoIP traffic.

A network assessment should include a determination of the following:

- A network audit to review existing equipment and evaluate its capabilities, including its ability to meet both current and planned voice and data needs.
- A determination of network objectives, including the dominant traffic type, choice of technologies and setting voice quality objectives.
- The assessment should leave you confident that the network will have the capacity for the foreseen data and voice traffic.

Network Assessment Targets

The network assessment targets are:

- Latency: Less than 180ms for good quality. Less than 80ms for toll quality. This is the measurement of packet transfer time in one direction. The range 80ms to 180ms is generally acceptable. Note that the different audio codecs used each impose a fixed delay caused by the codec conversion as follows:
 - G.711: 20ms.
 - G.722: 40ms.
 - G.729: 40ms.
- Packet Loss: Less than 3% for good quality. Less than 1% for toll quality. Excessive packet loss will be audible as clipped words and may also cause call setup delays.
- Jitter: Less than 20ms. Jitter is a measure of the variance in the time for different packets in the same call to reach their destination. Excessive jitter will become audible as echo.
- Duration: Monitor statistics once every minute for a full week. The network assessment must include normal hours of business operation.

Related links

[IP Office H.323 IP Phones](#) on page 10

Voice Compression Channels

Calls to and from IP devices can require conversion to the audio codec format being used by the IP device. For IP Office systems this conversion is done by voice compression channels. These support the common IP audio codecs G.711, G.722, and G.729a.

- For the IP500 V2 control units, channels can be added using IP500 VCM cards and IP500 Combination Cards.

- IP Office Server Edition systems provide their own voice compression channels through software without requiring additional hardware.

The voice compression channels are used as follows:

Call Type	Voice Compression Channel Usage
IP Device to Non-IP Device	These calls require a voice compression channel for the duration of the call. If no channel is available, busy indication is returned to the caller.
IP Device to IP Device	<p>Call progress tones (for example dial tone, secondary dial tone, etc) do not require voice compression channels with the following exceptions:</p> <ul style="list-style-type: none"> • Short code confirmation, ARS camp on and account code entry tones require a voice compression channel. <p>When a call is connected:</p> <ul style="list-style-type: none"> • If the IP devices use the same audio codec no voice compression channel is used. <p>If the devices use differing audio codecs, a voice compression channel is required for each.</p>
Non-IP Device to Non-IP Device	No voice compression channels are required.
Music on Hold	This is provided from the IP Office's TDM bus and therefore requires a voice compression channel when played to an IP device.
Conference Resources and IP Devices	Conferencing resources are managed by the conference chip which is on the IP Office's TDM bus. Therefore, a voice compression channel is required for each IP device involved in a conference. This includes services that use conference resources such as call listen, intrusion, call recording and silent monitoring.
Voicemail Services and IP Devices	Calls to the IP Office voicemail servers are treated as data calls from the TDM bus. Therefore calls from an IP device to voicemail require a voice compression channel.
Fax Calls	These are voice calls but with a slightly wider frequency range than spoken voice calls. IP Office only supports fax across IP between IP Office systems with the Fax Transport option selected. It does not currently support T38.
T38 Fax Calls	<p>IP Office 5.0+ supports T38 fax on SIP trunks and SIP extensions. Each T38 fax call uses a VCM channel.</p> <p>Within a Small Community Network, a T38 fax call can be converted to a call across an H.323 SCN lines using the IP Office Fax Transport Support protocol. This conversion uses 2 VCM channels.</p> <p>In order use T38 Fax connection, the Equipment Classification of an analog extension connected to a fax machine can be set Fax Machine. Additionally, a new short code feature Dial Fax is available.</p>

 **Note:**

T3 IP devices must be configured to 20ms packet size for the above conditions to apply. If left configured for 10ms packet size, a voice compression channel is needed for all tones and for non-direct media calls.

Measuring Channel Usage

The IP Office system Status Application can be used to display voice compression channel usage. Within the Resources section it displays the number of channel in use. It also displays how often there have been insufficient channels available and the last time such an event occurred.

For IP500 VCM cards, the level of channel usage is also indicated by the LEDs (1 to 8) on the front of the IP500 VCM card.

Related links

[IP Office H.323 IP Phones](#) on page 10

QoS

When transporting voice over low speed links it is possible for normal data packets (1500 byte packets) to prevent or delay voice packets (typically 67 or 31 bytes) from getting across the link. This can cause unacceptable speech quality.

Therefore, it is vital that all traffic routers and switches in the network have some form of Quality of Service (QoS) mechanism. QoS routers are essential to ensure low speech latency and to maintain sufficient audio quality.

IP Office supports the DiffServ (RFC2474) QoS mechanism. This is based upon using a Type of Service (ToS) field in the IP packet header. On its WAN interfaces, IP Office uses this to prioritize voice and voice signalling packets. It also fragments large data packets and, where supported, provides VoIP header compression to minimize the WAN overhead.

Related links

[IP Office H.323 IP Phones](#) on page 10

Potential VoIP Problems

It is likely that any fault on a network, regardless of its cause, will initially show up as a degradation in the quality of VoIP operation. This is regardless of whether the fault is with the VoIP telephony equipment. Therefore, by installing a VoIP solution, you must be aware that you will become the first point of call for diagnosing and assessing all potential customer network issues.

	Description
End-to-End Matching Standards	VoIP depends upon the support and selection of the same voice compression, header compression and QoS standards throughout all stages of the calls routing. The start and end points must be using the same compression methods. All intermediate points must support DiffServ QoS.

Table continues...

	Description
Avoid Hubs	Hubs introduce echo and congestion points. If the customer network requires LAN connections beyond the capacity of the IP Office Unit itself, Ethernet switches should be used. Even if this is not the case, Ethernet switches are recommended as they allow traffic prioritization to be implemented for VoIP devices.
Power Supply Conditioning, Protection and Backup	Traditional phone systems provide power to all their attached phone devices from a single source. In a VoIP installation, the same care and concern that goes into providing power conditioning, protection and backup to the central phone system, must now be applied to all devices on the IP network.
Multicasting	In a data only network, it is possible for an incorrectly installed printer or hub card to multicast traffic without that fault being immediately identified. On a VoIP network incorrect multicasting will quickly affect VoIP calls and features.
Duplicate IP Addressing	Duplicate addresses is a frequent issue.
Excessive Utilization	A workstation that constantly transmits high traffic levels can flood a network, causing VoIP service to disappear.
Network Access	An IP network is much more open to users connecting a new device or installing software on existing devices that then impacts on VoIP.
Cabling Connections	Technically VoIP can (bandwidth allowing) be run across any IP network connection. In practice, Cat5 cabling is essential.

Related links

[IP Office H.323 IP Phones](#) on page 10

User PC Connection

To simplify the number of LAN connections from the user's desk, it is possible to route their PC Ethernet LAN cable via most Avaya IP phones.

The LAN cable should be connected from the PC to the socket with a PC symbol () at the back of the IP phone. The PC's network configuration does not need to be altered from that which it previously used for direct connection to the LAN. This port supports 10/100Mbps ethernet connections. Phones with a G suffix also support 1000Mbps Gigabit connections.

For phones without a PC port, a separate Gigabit Adapter (SAP 700416985) must be used. This device splits the data and voice traffic before it reaches the phone, providing a 10/100Mbps output for the phone and a 10/100/1000Mbps output for the PC. The adapter is powered from the phone's existing power supply. Refer to the "*Gigabit Ethernet Adapter Installation and Safety Instructions*" (16-601543).

Related links

[IP Office H.323 IP Phones](#) on page 10

Power Supply Options

Each H.323 IP phone requires a power supply. They do not draw power from the phone system. Listed below are the power supply options that can be used.

IEEE 802.3af is a standard commonly known as Power over Ethernet (PoE). It allows network devices to receive power via the network cable using the same wires as the data signals. All the Avaya H.323 IP phones supported on IP Office also support this standard.

Where a large number of phones is being installed, the use of PoE switches is recommended. For other scenarios, individual PoE injector devices can be used to add PoE power support to the phone's LAN connection from a non- PoE switch.

H.323 IP Phones	Supported Models	802.3af PoE Class	
		Class	Idle
1600 Series	1603	2	4.4W
	1603W	2	4.4W
	1608	2	3.7W
	1616	2	2.7W
9600 Series	9608	1	2.08W
	9611G	1	2.8W
	9621G	2	3.49W
	9641G	2	3.44W

These 1603 and 1603SW phones require a separate PoE Splitter unit in order to use PoE.

Exceeding the Class limit of a PoE port or the total Class support of a PoE switch may cause incorrect operation.

Note that for phones being used with an add-on button module unit and other accessories the power requirements are higher. For 9608, 9611, 9621, and 9641 phones, set the phone power switch to H and treat the phone as Class 3.

1600 Series Phones

These phones can use either PoE as above or can be powered from using 1600 Series plug-top power supply units (PSUs). Different models of PSU exist for the various type of mains power outlets in different countries. The PSU connects to the phone using a barrel connector under the phone.

9608, 9611, 9621 and 9641 Phones

These phones only support a Power over Ethernet (PoE) connector. If not being supplied with a PoE switch, a separate Avaya Global Single Port PoE injector can be used for each phone.

Related links

[IP Office H.323 IP Phones](#) on page 10

File Server Options

During installation and maintenance, the phones download various firmware files . In order to do this, a phone requests files for an HTTPS server first. If it gets no response, it then tries to obtain the files from an HTTP server. The address of the server to use is provided as part of the DHCP response that the phone received from the DHCP server. If the IP Office system is being used as the DHCP server, the file server address is set as part of the IP Office configuration. For phones installed using static addressing, the file server address is one of the addresses entered during installation.

- Each phone will attempt to request files from the file server every time it is restarted. However, if the phone does not receive any response, it will continue restarting using the existing files that it has in its own memory. Therefore there is no requirement for the file server to be permanently available after initial installation.
- The phones also use a server for the backup and restoration of user settings during phone operation. The address for this server is defined by a separate address set found in the `46xxsettings.txt` file. It is not necessarily the same server that is used for the phone firmware. However, for IP Office operation, the address of the IP Office server is recommended for use as the backup/restore file server.

The following options are available for the file server for IP phones being installed on an IP Office system.

File Server	Up to X Phones	TFTP (Port 69)	HTTP (Port 80)	HTTPS (Port 411)
IP Office Manager When running, IP Office Manager can act as a HTTP/ TFTP server for file requests from IP phones.	5	✓	✓	-
IP500 V2 Memory Card For IP Office control units fitted with a memory card, that card can be used to provided the software files. For IP500 V2 control units the System SD card is a mandatory item and is pre-loaded with the phone firmware files during card creation and upgrades. Various other files can be auto-generated by the IP Office if not present on the memory card.	50	✓	✓	✓
IP Office Server Edition/IP Office Select For IP Office systems, the IP Office application can act as the file server. The phone firmware files are installed onto the server as part of the IP Office installation. Various other files can be auto-generated by the IP Office if not present on the memory card.	1	-	✓	✓

Table continues...

File Server	Up to X Phones	TFTP (Port 69)	HTTP (Port 80)	HTTPS (Port 411)
3rd Party Software 3rd Party HTTP/TFTP file server software is available from many sources including Avaya.	-	✓	✓	✓

¹ Within a IP Office Server Edition/IP Office Select network, the servers (other than an IP500 V2 Expansion) can act as file server for the systems full capacity of phones. However, the rate at which updated firmware delivery is supported depends on the server type as follows. If upgrade performance above these figures is required, an external HTTP/S file server can be used.

- Dell R240: 100 phones per 50 minutes.
- HP DL360G7: 200 phones per 50 minutes.
- Dell R640: 300 phones per 50 minutes.
- OVA: Up to 300 phones per 50 minutes.

² For IP Office Release 9.0, for IP Office systems acting as the file server, HTTP redirection can be applied to redirect 9608, 9611, 9621 and 9641 phone requests for .bin files to a separate HTTP server.

Related links

[IP Office H.323 IP Phones](#) on page 10

Control Unit Memory Cards

The memory card used with IP500 V2 systems can be used to store files including those used by Avaya IP Phones.

The IP500 V2 control unit requires a System SD card at all times. During creation of this card, a full set of IP Office firmware files including those used by Avaya IP phones is placed onto the card.

Testing the File Server

You can use a web browser to perform a basic test of the file server. For example, if using HTTP, entering `http://<server_address>/46xxsettings.txt` should display the `46xxsettings.txt` file.

If using the IP Office system to auto-generate files, the settings file includes text indicating that it was automatically generated by the system in response to the file request. This is useful to not only check the file server operation but to also see the settings being supplied by the IP Office system.

Related links

[IP Office H.323 IP Phones](#) on page 10

Phone File Requests

When starting, most Avaya IP phones go through a process of requesting various files from a file server:

1. Usually this starts with a request an upgrade file. That file will indicate what firmware the phone should be running. If this differs from the firmware it is running, it will add the software files listed to those it will download. The last line of the upgrade file tells the phone the name of settings file it should request.
2. The phone requests a settings file. This passes a large number of configuration settings to the phone. It may also list additional files that the phone should request such as language files and screen savers.
3. The phone requests additional files:
 - Any firmware files indicated by the upgrade file.
 - Any additional files indicated by the settings file.
 - Any additional settings files.
4. The phone can also request a user settings file.

The above is just a general summary. Depending on the phone, the order of file request may vary. In addition, if requesting firmware for an upgrade, the phone may not request other files until the firmware upgrade has been completed and it has restarted.

When the IP Office system is used as the file server, it has the ability to auto-generate many of the files requested by the phone.

Related links

[IP Office H.323 IP Phones](#) on page 10

[File Auto-Generation](#) on page 25

File Auto-Generation

Avaya IP phones request a number of files from the file server when the phone is restarted. For example phone configuration and firmware files.

When using the IP Office system as the file server, when the phone requests a file, if that file is not available the system may auto-generate a file. The auto-generated file will use a combination of default options and settings from the system configuration. Once supplied to the requesting phone the auto-generated file is not retained on the system.

This feature is used for most of the file types except for actual firmware files (example `.bin`, `.zip`, `.tar`) and certificate files. If an actual file is uploaded to the system , auto-generation of that particular file stops.

Within the auto-generated `46xxsettings.txt` file:

- Those settings based on IP Office configuration entries, for example language settings, appear in the sections labeled "AUTOGENERATEDSETTINGS".

- Those settings that remain the same for all IP Office systems using the same release of software appear in the section labeled "NONAUTOGENERATEDSETTINGS".

Testing the File Server

You can use a web browser to perform a basic test of the file server. For example, if using HTTP, entering `http://<server_address>/46xxsettings.txt` should display the `46xxsettings.txt` file.

If using the IP Office system to auto-generate files, the settings file includes text indicating that it was automatically generated by the system in response to the file request. This is useful to not only check the file server operation but to also see the settings being supplied by the IP Office system.

Related links

[Phone File Requests](#) on page 25

Control unit memory card

The memory card used with IP500 V2 systems can be used to store files including those used by Avaya IP Phones.

The IP500 V2 control unit requires a System SD card at all times. During creation of this card using IP Office Manager, a full set of IP Office firmware files including those used by Avaya IP phones is placed onto the card.

Related links

[IP Office H.323 IP Phones](#) on page 10

Registration Blacklisting

The IP Office system logs failed H323/SIP registration requests. Multiple failed attempts can lead to the extension and/or IP address becoming blocked for a period.

Blocking applies as follows:

Method	Description
Extension Blocking	Registration attempts to an existing extension using the wrong password are blocked for 10 minutes after 5 failed attempts in any 10 minute period.
IP Address Blocking	Registration attempts to a non-existent extension or using the wrong password of an existing extension are blocked for 10 minutes after 10 failed attempts in any 10 minute period.

When blocking occurs, the system generates an alarm in System Status Application and adds an entry to its audit log. A system alarm is also generated and can be output using any of the supported system alarm routes (SMTP, SNMP, Syslog).

System Monitor can display details of blacklisted IP addresses and extensions, select **Status > Blacklisted IP Addresses and Status > Blacklisted Extensions**.

Related links

[IP Office H.323 IP Phones](#) on page 10

Blocking Default Passcodes

About this task

For IP Office R11.0 and higher, the default security settings block the use of default phone passwords such as 0000 for extension registration.

Procedure

1. Using IP Office Manager, access the system's security configuration.
2. On the **General** tab, clear **Block Default IP Phone Passcodes** checkbox.
3. Save the settings.

Related links

[IP Office H.323 IP Phones](#) on page 10

Chapter 2: Additional Phone Settings

The auto-generated `46xxsettings.txt` settings files are suitable for most installations. However, in some scenarios it may be necessary to amend the value of the file settings or to add additional settings. This can be done in a number of ways:

- **Using Static Files:** Replace the auto-generated file with an actual file. The method is only recommended for those experienced with the editing of Avaya phone settings files. The major drawback is that you no longer benefit from the automatic changing of settings to match changes in the IP Office configuration. See [Configuring and editing file settings](#) on page 30.
- **Use a settings file:** If a file called `46xxsettings.txt` is present on the system, then the auto-generated `46xxsettings.txt` file instructs the phone to request that file. This allows you to upload a special file that contains any additional settings or override selected settings in the auto-generated file. See [46xxspecials.txt](#) on page 29.
- **Use NoUser Source Numbers:** There are a number of NoUser source number settings that can be used to add special values to the autogenerated settings file. See [NoUser Source Numbers](#) on page 30.

Common Additional Commands

The following are some of the frequently used additional commands. For full details of commands available refer to the appropriate Avaya administrator's manual for the particular series of phones.

Description	Setting File Command
Password/CRAFT Set the PROCPSWD specified in the auto-generated <code>46xxsettings.txt</code> file where X is the password. This is useful scenarios such as TLS operation which cannot be enabled on phones with the default PROCPSWD.	SET PROCPSWD X
Administrators Password Set the Vantage phone administrator password specified in the auto-generated <code>46xxsettings.txt</code> file where X is the password.	SET ADMIN_PASSWORD X
Headset Operation By default, the phone headset goes back on-hook when the other party disconnects. Setting this source number changes that behavior so that headset remains off-hook when the other party disconnects.	SET HEADSYS 1

Table continues...

Description	Setting File Command
Backlight Timer Sets the timer in minutes for the phone backlight timer.	SET BAKLIGHTOFF 60
Screen Saver This set of commands <ol style="list-style-type: none"> 1. Enable the screen saver 2. Set the name of screen saver to download 3. Sets the name of the current downloaded file to use. 	SET SCREENSAVERON SET SCREENSAVER_IMAGE J179scr_svr.jpg SET SCREENSAVER_IMAGE_DISPLAY J179scr_svr
Background Image This set of commands <ol style="list-style-type: none"> 1. Set the name of the background image to download 2. The name of the current downloaded file to use. 	SET BACKGROUND_IMAGE J179bck_grnd.jpg SET BACKGROUND_IMAGE_DISPLAY J179bck_grnd

There are several NoUser source numbers used for remote extension. They operate differently in that they change existing values in the auto-generated settings file given to a phone when the system detects that the phone requesting the file is a remote extension. See the "*IP Office SIP Phones with ABSCE*" manual.

Related links

[46xxspecials.txt](#) on page 29

[NoUser Source Numbers](#) on page 30

[Configuring and editing file settings](#) on page 30

46xxspecials.txt

For systems using the auto-generated 46xxsettings.txt file, one option to add additional manual settings is to use a file called 46xxspecials.txt. When such a file is added to the system, the command **GET 46xxspecials.txt** appears as the last line of the auto-generated 46xxspecials.txt file requested by phones.

The 46xxspecials.txt file needs to be manually created and then placed on the phone file server. It can be a:

- Simple text file containing a single command
- Complex settings file with settings based on phone type, model, group, or model and group

To obtain an example of a complex structure, you can browse to <http://<IPOffice>/46xxspecials.txt> to obtain an auto-generated file. Save and edit that file before uploading it back to the system.

Related links

[Additional Phone Settings](#) on page 28

NoUser Source Numbers

Most values in the auto-generated settings file are based on settings taken from the IP Office system configuration. However, it may occasionally be necessary to add additional values to the auto-generated files. This can be done using the values entered as `NoUser` source numbers.

- Since these changes are applied to the values in the auto-generated `46xxsettings.txt` file, they are overridden by any setting entered in the `46xxsettings.txt` file if present.
- There are a number of **NoUser** source number settings used for remote extensions. They operate differently in that they change existing values in the auto-generated settings file given to a phone when the system detects that the phone requesting the file is a remote extension. Refer to the [IP Office SIP Phones with ASBCE](#) manual.

Example NoUser Source Numbers

	Description
<code>SET_46xx_PROCPSWD=X</code>	This NoUser source number adds the command <code>SET PROCPSWD X</code> to the auto-generated settings file where <code>X</code> is the password set.
<code>SET_ADMINPSWD=X</code>	This NoUser source number adds the command <code>SET ADMINPSWD X</code> to the auto-generated settings file where <code>X</code> is the password set.
<code>SET_HEADSYS_1</code>	This NoUser source number adds the command <code>SET ADMINPSWD X</code> to the auto-generated settings file.
<code>SET_BAKLIGHTOFF=N</code>	This NoUser source number adds the command <code>SET BAKLIGHTOFF N</code> to the auto-generated settings file provided to a remote extension. <code>N</code> is the timeout in minutes.

Related links

[Additional Phone Settings](#) on page 28

Configuring and editing file settings

About this task

Most Avaya IP phones download a settings file when restarted, This file contains a range of settings.

Note:

Where possible that you use the IP Office system's as the file server and let it auto-generate the settings files. This helps as the system automatically adjusts the settings provided to phones to match changes made in the system configuration.

Procedure

1. Browse to the system and enter the name of the particular phone settings file required, for example <http://192.168.42.1/46xxsettings.txt>. The auto-generated file is displayed in the browser.

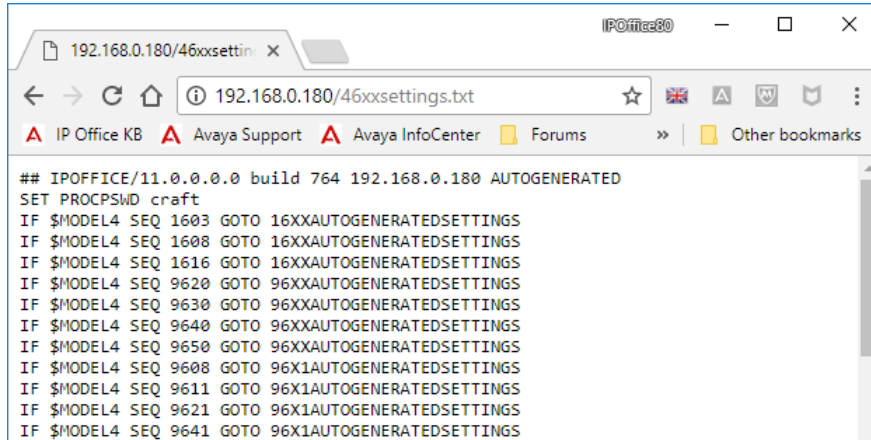

```
## IPOFFICE/11.0.0.0.0 build 764 192.168.0.180 AUTOGENERATED
SET PROCPSWD craft
IF $MODEL4 SEQ 1603 GOTO 16XXAUTOGENERATEDSETTINGS
IF $MODEL4 SEQ 1608 GOTO 16XXAUTOGENERATEDSETTINGS
IF $MODEL4 SEQ 1616 GOTO 16XXAUTOGENERATEDSETTINGS
IF $MODEL4 SEQ 9620 GOTO 96XXAUTOGENERATEDSETTINGS
IF $MODEL4 SEQ 9630 GOTO 96XXAUTOGENERATEDSETTINGS
IF $MODEL4 SEQ 9640 GOTO 96XXAUTOGENERATEDSETTINGS
IF $MODEL4 SEQ 9650 GOTO 96XXAUTOGENERATEDSETTINGS
IF $MODEL4 SEQ 9608 GOTO 96X1AUTOGENERATEDSETTINGS
IF $MODEL4 SEQ 9611 GOTO 96X1AUTOGENERATEDSETTINGS
IF $MODEL4 SEQ 9621 GOTO 96X1AUTOGENERATEDSETTINGS
IF $MODEL4 SEQ 9641 GOTO 96X1AUTOGENERATEDSETTINGS
```

- Most Phones: 46xxsettings.txt
 - 1100/1200 Series: 11xxsettings.txt
 - H175: H1xxsettings.txt
2. Save the file as a local text file.
 - To save the file using Chrome browser, right-click on the window and select **Save As**.
 - To save the file using Explorer browser, select **File > Save As**.
 - To save the file using Firefox browser, select **Save Page As**.

The downloaded file can now be edited using a text editor. The supported fields are described in the appropriate administration manual for the phone series.

3. When completed, upload the file to the file server being used by the telephones.
4. Restart the phone or phones in order for them to reload their files including downloading the edited settings file.

Related links

[Additional Phone Settings](#) on page 28

Part 2: Basic Installation Process

H.323 IP Phone Installation

The following is a summary of the major steps in the installation process. The recommended installation method is to use DHCP where possible, to use the IP Office system as the file server and to enable automatic user and extension creation.

	Description
Manager PC:	Check that IP Office Manager, System Status Application and System Monitor are installed and can be used to connect to the IP Office system. Verify that you can receive the configuration from the system and send it back.
Voice Compression Channels	For IP500 V2 systems, the control unit must be fitted with voice compression channels . Use either System Status Application (SSA) or System Monitor application to verify that the voice compression channels are available. SSA list the Voice Compression Modules (VCM) channels on the Resources screen. The initial lines of Monitor output include the item VCOMP= which states the number of channels installed in the control unit.
Licenses or Subscriptions	Depending on the system's operating mode, each phone requires a license or subscription. Phones without a license or subscription can register but will not operate. See Licenses and Subscriptions on page 17.
H.323 Gatekeeper Settings	The IP Office system has support for H.323 phones enabled by default. However, the setting should be checked.
DHCP Server Setting	DHCP is the recommended method for installation of IP phones on a IP Office system. This requires a DHCP server configured to support IP phones. The IP Office system can be used for this. If the customer want to use their own DHCP server, it requires additional configuration
Phone File Server Setting	If the IP Office system is being used for DHCP, it also needs to be configured with the address of the file server. Whichever installation method and file server is selected, the phone firmware files need to be added to the files available on the server.

Table continues...

	Description
Extension and User Settings	The IP Office system can be configured to automatically create user and extension entries in its configuration for each IP phone that is installed. If automatic creation is not used, entries must be manually created for each extension and user before the phones are installed.
Phone Connections	Once the steps above have been completed, the phones can be connected to the network. If using DHCP, the phones will automatically obtain IP address information and other settings and then start loading files. If not using DHCP, the phones will have to be taken through a manual process of entering the IP address information and settings.
Phone Registration	Once the phones have downloaded all the files they require from the file server, they will attempt to register with the IP Office system. The phones will prompt for entry of the extension number that they should use.
Testing	Operation of the phones should be tested by making a number of calls, including external calls.
Post Installation	If auto-creation was used for the extension and or user entries, those settings should be disabled after installation of all the phones is completed. This manual only details the minimum user configuration necessary for installation. The new users can now be fully configured to meet the customer requirements for those users.

Chapter 3: Licenses and Subscriptions

Subscriptions

Systems running in subscription mode support extensions up to the total number of user subscriptions available.

Licenses

For systems not running in subscription mode, licenses are required for each IP extension.

- On IP Office Server Edition systems, the user must be configured to a licensed user profile with a user license such as the Basic User license. Unlicensed users cannot login to an extension.
- For Avaya phones, an Avaya IP Endpoint license is required for each phone. This includes all 1600, 9600, IP DECT, DECT R4 and Spectralink.
- For non-Avaya IP phones, a Third-Party IP Endpoint license is required.
 - By default licenses are consumed by each Avaya IP phone that registers with the IP Office in the order that they register. The license is released if the phone unregisters. However, it is possible to reserve a license for particular phones in order to ensure that they phones always obtain a license. This is done through the **Reserve Avaya IP Endpoint License** setting of each IP extension. On system's using WebLM licensing, this option is fixed to reserve a license.
 - Avaya IP phones without a license are still be able to register but are limited to making emergency calls only (Dial Emergency short code calls). The associated user is treated as if logged off and the phone displays "No license available". If a license becomes available, it is assigned to any unlicensed DECT handsets first and then to any other unlicensed Avaya phones in the order that the phones registered.

Related links

[IP Office H.323 IP Phones](#) on page 10

[Reserving Licenses](#) on page 34

Reserving Licenses

About this task

This particular process cannot normally be done until the extension entry has been created. If using automatic extension creation (the default), this means that license reservation cannot be done until after initial installation of the phone. However, consideration should be given to using this setting with any existing phones already installed in order to ensure that they retain their licenses if possible following the addition of other phones.

Licenses are normally automatically assigned to extensions in order of registration. However existing extensions can reserve a license in order to ensure they do not become unlicensed when new extensions added to the system manage to register first following a system reboot.

- On system's using WebLM licensing, this option is fixed to reserve a license.
- License reservation is not supported on subscription mode systems.

Procedure

1. Using IP Office Manager, receive the configuration from the telephone system.
2. Select  **Extension** and then select the H.323 extension.
3. Select the **VoIP** tab.
4. Set the **Reserve License** field to **Reserve Avaya IP endpoint license**.
5. Repeat the process for any other extensions for which you want to reserve the license.
6. Save the configuration.

Related links

[Licenses and Subscriptions](#) on page 17

Chapter 4: Enabling the H.323 Gatekeeper

About this task

Support for H.323 telephones and lines is enabled by default. However, the settings should be checked.

Procedure

1. Using IP Office Manager, retrieve the configuration from the system.
2. Select  **System**
3. Select the **LAN1** or **LAN2** tab depending on which of the system's LAN interfaces you want to use to support H.323 extensions.
4. Select the **VoIP** sub-tab.

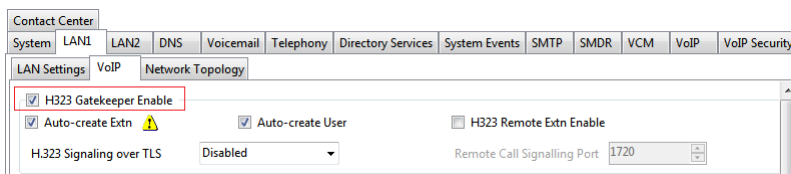

5. Enable the **H323 Gatekeeper Enable** setting checkbox.
6. Save the configuration.

Related links

[Setting the RTP Port Range](#) on page 36

[Adjusting DiffServ QoS](#) on page 38

[System Default Codecs](#) on page 38

Setting the RTP Port Range

About this task

The ports used for H.323 VoIP calls vary for each call. The range for the ports used can be adjusted in order to avoid conflict with other services. If the customer has any internal firewalls or similar equipment that applies port filtering or only forwards traffic based on the port used, the range set here must be allowed by those devices.

For each VoIP call, receive ports are selected from the range defined below. Even numbers in the range are used for the calls incoming Real-Time Transport Protocol (RTP) traffic. The same calls Real-Time Transport Control Protocol (RTCP) traffic uses the RTP port number plus 1, that is the odd numbers.

It is recommended that only port numbers greater than or equal to 49152 but strictly less than 65535 are used, that being the range defined by the Internet Assigned Numbers Authority (IANA) for dynamic usage.

Procedure

1. Using IP Office Manager, retrieve the configuration from the system.
2. Select  **System**
3. Select the **LAN1** or **LAN2** tab depending on which of the system's LAN interfaces you want to use to support H.323 extensions.
4. Select the **VoIP** sub-tab.

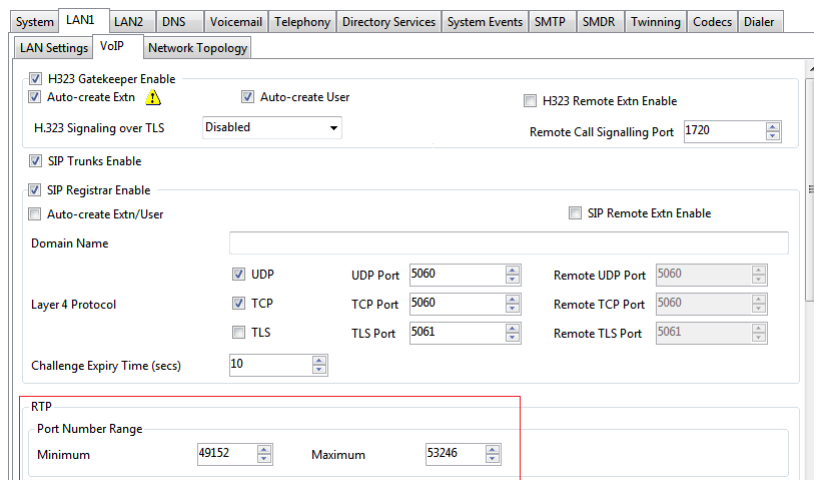

The screenshot shows the configuration interface for the VoIP settings of a LAN interface. The 'RTP' section is highlighted with a red box, showing the 'Port Number Range' with a Minimum of 49152 and a Maximum of 53246. Other visible settings include H323 Gatekeeper Enable, Auto-create Extn, Auto-create User, H323 Remote Extn Enable, SIP Trunks Enable, SIP Registrar Enable, and various port settings for UDP, TCP, and TLS.

5. Check the **Port Number Range** shown in the **RTP** section. Remember that the matching RTCP traffic uses the same range plus 1.

- **Minimum:** Default = 49152. Range = 1024 to 65280.

This sets the lower limit for the RTP port numbers used by the system. Choosing a minimum range of less than 1024 should only be done after careful analysis of the overall configuration.

- **Maximum:** Default = 53246. Range = 1278 to 65534.

This sets the upper limit for the RTP port numbers used by the system. The gap between the minimum and the maximum must be at least 254. Choosing a minimum range of less than 1024 should only be done after careful analysis of the overall configuration.

6. Save the configuration.

Related links

[Enabling the H.323 Gatekeeper](#) on page 36

Adjusting DiffServ QoS

About this task

DiffServ is used to apply different 'quality of service' tags to the voice (RTP) and control signal (RTCP) elements of a VoIP call. The IP Office system itself does not apply any different priority to data packets its receives or sends based on their tags. However, when being used in a network where QoS is being used for prioritization by other devices, the IP Office's settings should be set to match those expected for voice calls and their associated control signalling.

Procedure

1. Using IP Office Manager, retrieve the configuration from the system.
2. Select **System**
3. Select the **LAN1** or **LAN2** tab depending on which of the system's LAN interfaces you want to use to support H.323 extensions.
4. Select the **VoIP** sub-tab.

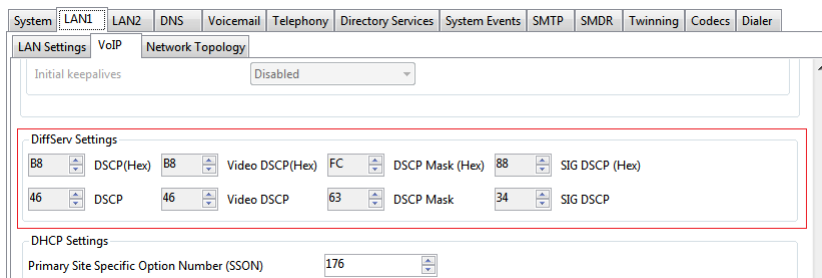

Check the **DiffServ Settings** that are being used by the system. Note that the two rows are linked, the upper row shows the DiffServ values in Hex numbers, the lower row shows the values in decimal. The hex values are equal to the decimal multiplied by 4. Either row can be used to set the required values.

5. Save the configuration.

Related links

[Enabling the H.323 Gatekeeper](#) on page 36

System Default Codecs

About this task

By default, all VoIP devices added to the IP Office configuration use the system's default codec preferences. This is shown by the **Codec** setting on an IP trunk or extension being set to **System Default**.

In addition to changing the default codec preference order for all VoIP trunks and extension, the codec preferences used by a particular trunk or extension can be adjusted. However, the use of the common system settings ensures codec consistency between trunks and extensions.

Procedure

1. Using IP Office Manager, retrieve the configuration from the system.
2. Select  **System**
3. Select the **VoIP** sub-tab.

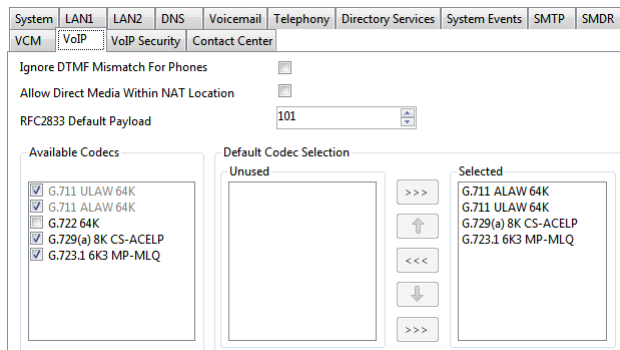

The screenshot shows the configuration page for 'System > VoIP > Contact Center'. The 'Default Codec Selection' section is active, showing a list of available codecs on the left and a list of selected codecs on the right. The selected codecs are G.711 ALAW 64K, G.711 ULAW 64K, G.729(a) 8K CS-ACELP, and G.723.1 6K3 MP-MLQ.

The Default Selection section is used to set the default codec preference order. This is used by all IP (H.323 and SIP) extensions and lines on the system that have their **Codec Selection** setting set to **System Default**. This is the default for all new added IP extension and lines.

The **Available Codecs** list shows which codecs the system supports. The codecs in this list which are enabled are those that can be used in other configuration forms including the adjacent default selection.

Warning:

Deselecting a codec in this list automatically removes it from all line and extension codec lists where it was being used.

4. Save the configuration.

Related links

[Enabling the H.323 Gatekeeper](#) on page 36

Chapter 5: DHCP Settings

The recommendation for H.323 phone installation is to use DHCP, especially if a large number of phones are being installed. Using DHCP simplifies both the installation and maintenance. There are a number of options around which server is used for the DHCP support for the H.323 phones:

- If the IP Office system is to be used as a DHCP server for the network, use the processes below to check and configure the system's DHCP settings.
- If a separate DHCP server is used by the customer's network, that DHCP server may need to be configured to support DHCP requests from IP phones
- The IP Office can be configured to only provide DHCP support for Avaya phones. That option can be used to allow it to be used in conjunction with a separate customer DHCP server. This removes the need to configure the customer's DHCP server for IP phone support.

 **Warning:**

- Enabling an additional DHCP server in a network can cause connection issues for all devices on the network. Ensure that you, the user, and the user's network administrator all agree upon the correct choice of DHCP server option.

Related links

[System DHCP Support](#) on page 40

[System Site Specific Option Numbers](#) on page 41

[Changing the system's SSON settings](#) on page 41

System DHCP Support

Procedure

1. Using IP Office Manager, retrieve the configuration from the system.
2. Select  **System**
3. Select the **LAN1** or **LAN2** tab depending on which of the system's LAN interfaces you want to use to support H.323 extensions.
4. Select the **LAN Settings** tab
5. In **Number of DHCP IP Addresses**, set the value for the number of IP addresses the system can issue.

6. Under **DHCP Mode** select **Server**.
7. Click **Advanced**. The **Advanced** settings allow adjustment of the **DHCP** setting including adding multiple ranges of **DHCP** numbers that the IP Office system can support. Note that address ranges outside those of the system's own subnet may also require the creation of appropriate IP routes to ensure traffic routing between the subnets.

 **Note:**

- Changes to the DHCP pools do not require a reboot of the IP Office system. However, it causes a reboot of Avaya H323 and SIP telephones connected to the system. Non-Avaya IP phones are not rebooted but may need to be manually restarted in order to obtain a valid address from the new pools configuration.

Select **Apply to Avaya IP Phone Only** checkbox.

The IP Office acts as a DHCP server for Avaya phones only. This option cannot be used if also supporting 1100 Series and 1200 Series phones.

8. Save the configuration.

Related links

[DHCP Settings](#) on page 40

System Site Specific Option Numbers

When requesting address settings from a DHCP server, each phone also requests additional information that the DHCP server may have by sending a Site Specific Option Number (SSON). If the DHCP server has information matching the SSON, that information is included in the DHCP response.

1600 and 9600 Series phones use 242 as their default SSON. However, through the phone's own menus the SSON it uses can be altered. For those phones using the IP Office system for DHCP, the SSON numbers that the IP Office supports are set in the IP Office system's configuration. The values used by the phones and supported by the IP Office system must match.

Related links

[DHCP Settings](#) on page 40

Changing the system's SSON settings

Procedure

1. Using IP Office Manager, retrieve the configuration from the system.
2. Select  **System**

DHCP Settings

3. Select the **LAN1** or **LAN2** tab depending on which of the system's LAN interfaces you want to use to support H.323 extensions.
4. Select the **VoIP** sub-tab.

The screenshot shows a configuration page with a top navigation bar containing tabs for VoIP Security, Contact Center, System, LAN1, LAN2, DNS, Voicemail, Telephony, Directory Services, System Events, SMTP, SMDR, VCM, and VoIP. Below this is a sub-navigation bar with tabs for LAN Settings, VoIP, Network Topology, and DHCP Pools. The main content area is divided into two sections: DiffServ Settings and DHCP Settings. The DHCP Settings section is highlighted with a red box and contains the following fields:

Field	Value
Primary Site Specific Option Number (4600/5600)	176
Secondary Site Specific Option Number (1600/9600)	242
VLAN	Not Present
1100 Voice VLAN Site Specific Option Number (SSON)	232
1100 Voice VLAN IDs	

5. Check that the site specific option number settings match those required for the phones being supported. The default for 1600 and 9600 Series phones is 242.
6. Save the configuration.

Related links

[DHCP Settings](#) on page 40

Chapter 6: File Server Settings

As part of the installation process, the phone requests for files from a file server. Using DHCP, address of the file server is obtained as part of the DHCP response from the DHCP server. The file server address is entered into the phone as part of the static addressing process.

The file server options are:

- For IP500 V2 systems, the IP Office system's own memory card can be used as the source for the files. This is the recommended option and can be used for up to 50 phones.
- For IP Office Server Edition systems, the system's own disk can be used as the source for the files used by the phones for the system' full supported phone's capacity.
- HTTP redirection can be used to allow a separate server to provide the binary files for 9600 and J100 Series phones whilst the IP Office system provides all other files.
- The IP Office Manager application can also act as a file server for up to 5 phones. If the options above are not acceptable or do not match the capacity needs of the system, a 3rd party HTTP file server is required. The necessary phone firmware files need to be loaded onto that server.

Port Usage

The port used by an IP phone to request files depends on the type of phone.

Port	Usage	Phones
80	Unsecure: Phone firmware, settings and user data.	All
411	Secure: Settings, user data.	9608, 9611, 9621 and 9641 H.323 Phones
443	Secure: Phone firmware, settings and user data.	SIP Phones
8411	Unsecure: Phone firmware.	H.323 Remote Phones

For most newer phones, the port to use can be indicated through the DHCP response or phone settings file first given to the phone. If there is no response on that port the phone may fallback to one of the default port values. However, for some older legacy phones are hard-coded to fixed ports.

Related links

[Changing the file server settings](#) on page 44

[Phone File Server Settings](#) on page 45

[Creating/Editing the Settings File](#) on page 45

[Manually Editing the File](#) on page 47

[Loading Software Files onto the System](#) on page 47

[IP500 V2 Control Unit](#) on page 48

[Using Embedded File Manager to Check/Upload Files](#) on page 48

[Manually Copying Files](#) on page 49

[Loading Files onto a third Party Server](#) on page 50

Changing the file server settings

About this task

If the IP Office system is being used for DHCP support for the IP phones, various settings in the IP Office system's configuration are used to set the file server addresses sent to the phones in the DHCP responses.

Procedure

1. Using IP Office Manager, retrieve the configuration from the system.
2. Select  **System**
3. Select the **System** tab.
4. Check the **Phone File Server Type** setting. See [Phone File Server Settings](#) on page 45.
5. In **Phone File Server Type** set the settings as required. See [Phone File Server Settings](#) on page 45 for details of the different settings usable.
6. **HTTP Redirection** can be used to send requests by 9600 Series and J100 Series phones for phone firmware (binary) files to the separate file server set by the **HTTP Server IP Address**. The options are:
 - **Off** - Do not redirect. Supply the phone firmware files from the IP Office system.
 - **Phone Binaries** - Redirect the requests to the file server address using HTTPS.
7. Enable the **Use Preferred Phone Ports** checkbox to reduce the use of the HTTP/HTTPS ports configured in the system's security configuration (by default ports 80 and 443) for phone file requests.
 - When enabled:
 - Auto-generated phone settings files for local phones indicates port 8411 for HTTP and 411 for TLS.
 - When cleared:
 - Auto-generated phone settings files provided by the system to local phones indicate the ports 80/411 or 80/443 depending on the phone type.
 - Auto-generated phone settings files provided by the system to remote phones indicate the ports 8411/411 or 8411/443 depending on the phone type.
8. Enable the **Avaya HTTP Clients Only** checkbox to restrict the system to responding to file requests from Avaya phones and applications only.

*** Note:**

This option should not be used if the system is also supporting 1100 and or 1200 Series phones.

9. Save the configuration.

Related links

[File Server Settings](#) on page 43

Phone File Server Settings

The following settings are used for H323 phones requesting firmware files from the IP Office system:

Field	Description
Memory Card (IP500 V2) Disk (IP Office Server Edition)	Use the system's own memory. The system's IP address is provided as the TFTP and HTTP file server values in the DHCP response. This is the default setting. When using this setting, the HTTP Redirection and HTTP Server IP Address settings can also be used to redirect firmware requests to a separate file server.
Manager	Use the IP Office Manager application as the TFTP and HTTP file server. This option is only supported for a maximum of 5 IP phones. This option uses the separate Manager PC IP Address set in the configuration. The default of 0.0.0.0 is used by the system to broadcast for any available IP Office Manager application running on the network. Note that by default the IP Office Manager option for TFTP support is disabled (File > Preferences > Preferences > Enable BootP and TFTP Servers).
Custom	This option uses the separate TFTP Server IP Address and HTTP Server IP Address values set in the configuration as the files server addresses in the DHCP response given to phones.

Related links

[File Server Settings](#) on page 43

Creating/Editing the Settings File

During installation, the phones request files first downloading an xxupgrade file from the file server. They then follow the instructions within that file to request further files if necessary. Various different xxupgrade files exist for the different phone series. These are provided as part of the phone firmware . The xxupgrade files should not be edited or changed in any way.

The last line of all the xxupgrade files instructs the phones to request the `46xxsettings.txt` file. This file can be used to set site specific settings for all the Avaya H.323 IP phones being supported on a particular site.

When using the IP Office system as the file server, the IP Office system will auto-create a suitable `46xxsettings.txt` file based on various IP Office system configuration settings. It will only do this if there is no actual `46xxsettings.txt` file available on the server.

Dialing Prefix

For IP Office systems the addition or removal of dialing prefixes is done by the IP Office system rather than individual phones, the use of enhanced dialing rules through the phone settings file is not supported.

802.1Q Tagging

Unless specifically required for the customer network, for IP Office operation it is recommended that `## SET L2Q 0` is changed to `SET L2Q 2`.

1600/9600 Series Phone Languages

In addition to English, the 1600 and 9600 phones can support up to 4 other languages. This is done by the phones, which download the language files specified in the `46xxsettings.txt` file. Currently 9 non-English language files are provided as part of the IP Office Manager installation.

Language	1600 File	9600 File
Dutch	<code>mlf_dutch.txt</code>	<code>mlf_9600_dutch.txt</code>
French Canadian	<code>mlf_french_can.txt</code>	<code>mlf_9600_french_can.txt</code>
French	<code>mlf_french_paris.txt</code>	<code>mlf_9600_french_paris.txt</code>
German	<code>mlf_german.txt</code>	<code>mlf_9600_german.txt</code>
Italian	<code>mlf_italian.txt</code>	<code>mlf_9600_italian.txt</code>
Portuguese	<code>mlf_portuguese.txt</code>	<code>mlf_9600_portuguese.txt</code>
Russian	<code>mlf_russian.txt</code>	<code>mlf_9600_russian.txt</code>
Spanish	<code>mlf_spanish.txt</code>	<code>mlf_9600_spanish.txt</code>
Spanish (Latin American)	<code>mlf_spanish_latin.txt</code>	<code>mlf_9600_spanish_latin.txt</code>

The files to download to the phones are defined in the `# SETTINGS1603`, `# SETTINGS1608` and `# SETTINGS1616` sections of the `46xxsettings.txt` file. To have the phone download a language file, remove the `##` in front of one of the `SET` options and change the file name to match the required language. If using the IP Office system as the file server, the appropriate language files based on the IP Office system configuration can be provided using file autogeneration

Backup/Restore

Phones can use an HTTP server as a location to which the user's phone settings are backed up and restore when they log on or off the phone. See [Backup/Restore Settings](#) on page 64 for full details.

Screensaver

You can specify how many minutes before an idle phone displays a screensaver image and the name of the image file. See [Screensaver](#) on page 62.

Related links

[File Server Settings](#) on page 43

Manually Editing the File

Procedure

1. Locate the `46xxsettings.txt` file on the file server.
2. Using a plain text editing tool, open the `46xxsettings.txt` file.
3. Edit the file as required.

The file contains numerous comments and notes. Further details of the various settings are contained in the appropriate Avaya LAN Administrator Manual for the type of phone. Note that the files contain a wide range of settings used on other Avaya telephone systems that may not necessarily work or be supported with IP Office systems.

A # character at the start of a line is the command on that line.

Related links

[File Server Settings](#) on page 43

Loading Software Files onto the System

For IP Office Server Edition systems, the phone firmware suitable for IP Office system operation is included as part of the IP Office system's installation onto the server. Therefore no further action is required if using the system as the file server for phone installation. The firmware is also included as part of IP Office Manager and is copied onto the PC when IP Office Manager is installed. No other firmware should be used with IP Office unless specifically documented. The firmware installed can be checked and new firmware copied onto the telephone system's disk if necessary.

The phone firmware suitable for IP Office system operation is supplied as part of the IP Office Manager software and is copied onto the PC when IP Office Manager is installed. No other firmware should be used with IP Office unless specifically documented.

There are a number of methods by which the firmware installed with IP Office can be copied onto the telephone system's memory card. The method used depends mainly on the type of control unit.

 **Warning:**

- A memory card should never be removed from a running system without either the card or the system first being shutdown. IP Office Manager should be used to shutdown the memory card before it is removed from the system.

- For IP Office operation, only the phone .bin files need to be present on the memory card. Other files required by the phones are automatically generated by the system in response to requests from the phones.

Related links

[File Server Settings](#) on page 43

IP500 V2 Control Unit

The system's System SD card is used to store the files. This is a mandatory card that is present in all IP500 V2 systems. The firmware files are loaded onto the card in a number of ways:

- If the system was upgraded using the **Recreate SD Card** option in IP Office Manager, the firmware is automatically copied onto the card as part of that process.
- If the system was upgraded using IP Office Manager's Upgrade Wizard, if the **Upload System Files** option was selected, the firmware is copied onto the card as part of that process. The **Upload System Files** option is enabled by default.

If you think the correct files are not present, you can use the embedded file manager part of IP Office Manager to check the files on the card and to copy the files onto the card if necessary.

Related links

[File Server Settings](#) on page 43

Using Embedded File Manager to Check/Upload Files

About this task

Embedded file manager allows you to remote see the files on the memory card used by the telephone system. It also allows you to upload new files.

Procedure

1. In IP Office Manager, select **File > Advanced > Embedded File Management**.

The **Select IP Office** menu is displayed.

2. Select the telephone system and click **OK**.

3. Enter the name and password for the system.

The contents of the memory card are displayed.

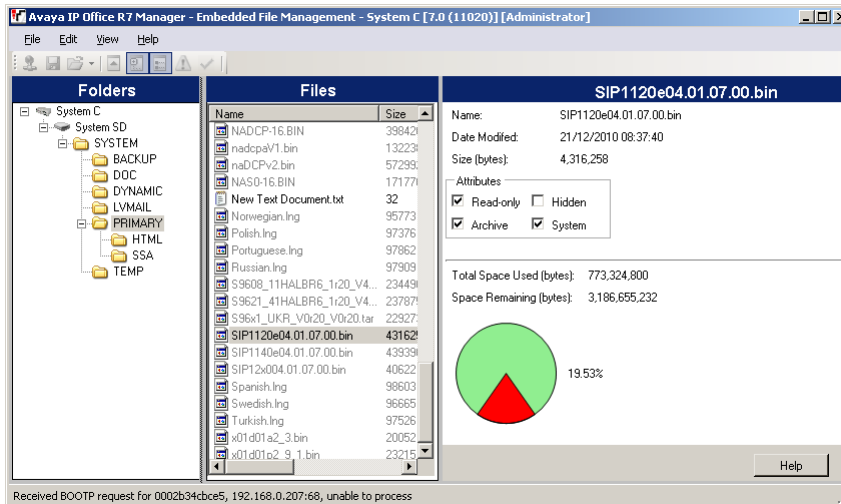

4. Do one of the following:
 - For IP500 V2 go to **System SD > SYSTEM > PRIMARY**.
 - For IP Office Server Edition go to **SYSTEM > PRIMARY**
5. To copy the files do any of the following:
 - Drag from **PRIMARY** and drop on memory card.
 - Go to **File > Upload System Files > Upload Phone Files** and select the file to copy.

The source files can be found on the IP Office Manager PC in C:\Program Files\Avaya\IPOffice\Manager\memory Cards\Common\system\primary.

Related links

[File Server Settings](#) on page 43

Manually Copying Files

About this task

Files can be copied onto the memory card by placing it into a PC with a suitable memory card slot.

Warning:

- A memory card should never be removed from a running system without first being shutdown using the process below.

Procedure

1. Using IP Office Manager, select **File > Advanced > Memory Card Command > Shutdown**.
Select IP Office menu is displayed.

2. Select the telephone system and click **OK**.
3. Enter the name and password for the system.
4. You may be prompted for which card you want to shutdown. Select **System** and click **OK**.
5. On the back of the control unit, check that the LED for the memory card slot is off before removing the memory card.
6. Place the card into the PC's memory card slot and examine the contents.
7. In IP500 V2 system, go to **System SD > SYSTEM > PRIMARY**.

The source files can be found on the IP Office Manager PC in `C:\Program Files\Avaya\IP Office\Manager\memory Cards\Common\system\primary`.

Result

When the card is reinserted into the system, card usage is automatically restarted.

Related links

[File Server Settings](#) on page 43

Loading Files onto a third Party Server

The phone firmware files are installed as part of the IP Office Manager application and are found in the application's installation directory. By default, the directory is found at `c:\Program Files\Avaya\IP Office\Manager`.

The same firmware files can also be obtained directly from the software package used to install IP Office Manager without having to perform the installation. The files are located in the `\program files\Avaya\IPOffice\Manager` sub-folder of the installation directory.

Note that these sets of files include .bin files that are also used for other devices including the IP Office system itself.

Related links

[File Server Settings](#) on page 43

Chapter 7: User and Extension Creation

When a new H.323 telephone registers with the system, the system can automatically create a new extension entry for the telephone in its configuration. It can also automatically create a new user entry for the telephone. Alternatively, if the phone registers using an extension number for which entries already exist, those entries are used so long as no other phone is already using them.

For new installations, Auto-creation can be used to ease the addition of multiple phones. The auto-create options must be disabled after installation. If Auto-creation is not used, extension and user entries need to be manually added to the configuration before attempting to install the phones.

Related links

- [Default Extension Password](#) on page 51
- [Manually Creating Users](#) on page 52
- [Manually Creating Extensions](#) on page 52
- [Selecting the required codec](#) on page 53
- [Using Auto-Creation](#) on page 54

Default Extension Password

About this task

Registration of most SIP phones requires entry of a password. This can be set through the system's **Extension Default Password** setting. Alternatively, for a particular extension a specific password can be set through the extension settings .

The auto-create extension settings in a system cannot be enabled until this value is set. It is then used as the password for any auto-created extensions.

Procedure

1. Using either IP Office Manager or IP Office Web Manager in offline mode, load the system configuration.
2. Select **System** or **System Settings > System**.
3. Select **VoIP**.
4. Select **VoIP Security**.
5. In the **Extension Default Password** section:
 - a. Click on the icon to view/hide the current password.

- b. If required, change or remove the password.

The password can either be blank or between 9 to 13 digits (0-9) in length.

6. Save the settings.

Related links

[User and Extension Creation](#) on page 51

Manually Creating Users

About this task

If the Auto-create User option is not enabled , you must manually create a user entry for each phone being installed. Use the procedure below to manually create an entry. It will also prompt whether a matching extension entry should also be created.

Procedure

1. Using IP Office Manager, retrieve the configuration from the system.
2. To display the list of existing users, click  **User**
3. Right-click on the right-hand panel and select **New**.
 - a. In the **User** tab set the following:
 - **Name**: Enter a name for the extension user. The name must be unique. If voicemail is in use, this name is used as the basis for a new mailbox with matching name.
 - **Extension**: This must match the extension number.
 - b. Click **OK**.

IP Office Manager prompts to create a matching extension.
 - c. Select **H.323 Extension** and enter the phone password for the extension click **OK**.
4. Save the configuration.

Related links

[User and Extension Creation](#) on page 51

Manually Creating Extensions

About this task

If the Auto-create Extn option is not enabled , you must manually create an extension entry for each phone being installed. This can be done either as part of the process of manually creating users or it must be done separately using the process below.

Procedure

1. Using IP Office Manager, retrieve the configuration from the system.
2. To display the list of existing extensions, click  **Extension**
3. Click **New**.
4. In the **Extn** tab, set the following:
 - a. **Extension ID**: For a VoIP extension, enter any number so long as it is unique, i.e. not already used by another extension.
 - b. **Base Extension**: Enter the extension number to assign to the phone. Again, this must be unique. This value is used to associate the extension with the user who has the same extension number.
 - c. **Phone Password**: This is the password used to register the phone with the system. If not set, the matching user's **Login Code** is used.
5. To add the new extension, click **OK**.
6. Save the configuration.

Related links

[User and Extension Creation](#) on page 51

Selecting the required codec

About this task

If the **Codec Selection** is set to **System Default**, the extension uses the system codec preferences. In most cases this is preferred and any changes required should be made at the system level to ensure consistency for all IP trunks and extensions.

However, if required, the **Codec Selection** of each individual trunk and extension can be adjusted to differ from the system defaults.

Procedure

1. Using IP Office Manager, retrieve the configuration from the system.
2. To display the extension's settings, click  **Extension**.
3. Select the **VoIP** tab.
4. Change the **Codec Selection** to **Custom**.

The **Unused** and **Selected** lists can be used to select which codecs the device uses and their order of preference.

5. Save the configuration.

Related links

[User and Extension Creation](#) on page 51

Using Auto-Creation

About this task

When installing a large number of phones, unless the configuration has been pre-built, auto-creation can be used to simplify the installation process. The auto-created users are automatically linked to the IP Auto-create user rights settings. By default that set of user rights has outgoing calls barred.

- Auto Disablement of Auto Create: Leaving the auto-create extension and user settings enabled is strongly deprecated. For Release 9.1 and higher, the system automatically disables the settings 24-hours after they are enabled.
- Not Supported with WebLM Licensing: The auto-create extension and user options are not useable on systems configured to acquire licenses from a WebLM service.

Before you begin

On R11.0.4.0 and higher systems, set the Default Extension Password before enabling auto-creation.

Procedure

1. Using IP Office Manager, retrieve the configuration from the system.
2. Select  **System**
3. Select the **LAN1** or **LAN2** tab depending on which of the system's LAN interfaces you want to use to support H.323 extensions.
4. Select the **VoIP** sub-tab.

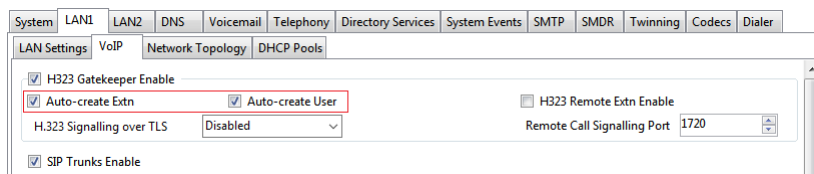

5. Set the **Auto-create Extn** and **Auto-create User** settings

Note:

It is necessary to manually create the extension entries and or manually create the user entries before installing the phones.

On pre-11.0.4.0 systems, when **Auto-create Extn** is selected, set and confirm a password. The password is set as the Phone Password for any extensions created using autocreation. The phone password is used for registration.

6. Save the configuration.

Related links

[User and Extension Creation](#) on page 51

Chapter 8: Connecting the phone

About this task

In this process the phone is connected to its power source and to the ethernet LAN. As soon as the phone is powered up it will start to request information.

Before you begin

Ensure you have completed installation of the phone before starting to connect the phone.

Procedure

1. Connect the network LAN cable to the data-in socket of the power supply being used for the phone.
2. Connect the LAN cable supplied with the IP phone from the power supplies data and power out socket to the socket with a LAN port  at the back of the IP phone.

The phone's message indicator should glow red for a few seconds. The phone begins its software loading process. After a short delay, the phone displays `Initializing` and then `Loading`. The loading phase may take a few minutes.

- If the phone has an existing software boot file (ie. it has been previously installed), it loads that file and then display `Starting`.

3. If the phone displays `No Ethernet`, check the connection to the LAN.

The phone displays `DHCP` and a timer as it attempts to request an IP address and other information from a DHCP server.

4. Press `*` whilst `DHCP` is displayed to switch to static address installation. See static address installation.

After a few seconds, DHCP negotiation is completed. If the timer reaches more than 60 seconds, it indicates an error in either the network or DHCP server configuration.

Once DHCP has completed successfully, the phone will request files from the file server indicated in the DHCP response. The first file requested details the other files that the phone should also load. The phone makes its file request using HTTPS. If this fails it makes the same request using HTTP. If that fails it makes a final request using TFTP. If all requests for a file fail, the phone fallbacks to using the current version of the file it has in its own memory.

The phone goes through a cycle of requesting files, loading files and then transferring the files into its flash memory.

Following file loading, the phone displays `Ext. =`. See [Registering phone](#) on page 56.

Related links

[Registering phone](#) on page 56

[Listing Registered Phones](#) on page 57

Registering phone

About this task

For new phones and phones that have been reset, the phone requests an extension number.

- If auto-create is enabled the extension number used, if free, creates new extension and user entries in the IP Office configuration.
- If auto-create is not enabled, the extension number used must match a VoIP extension entry within the IP Office configuration, see [Manually Creating Extensions](#) on page 52.

Procedure

1. In **Extn** enter the extension number the phone should use and press #.

 **Note:**

The phone displays `Wrong Set Type` if you try to use the extension number of an existing non-IP extension.

2. In **Password**, do any one of the following:

- If using auto-creation for a extension, enter the password that was specified while enabling auto-create.
- If not using auto-create, enter the **Phone Password** as set in the system configuration for the extension. If a **Phone Password** has not been set, the system checks against the matching user **Login Code**.

 **Note:**

The system disables the use of default passwords, such as 0000 which is supported by some phones. See [Blocking Default Passcodes](#) on page 27.

3. Test that you can make and receive calls at the extension.

Related links

[Connecting the phone](#) on page 55

Listing Registered Phones

About this task

The System Monitor application can be used to check which phones are registered with the system.

Procedure

1. Start System Monitor and connect to the IP Office system.
2. Select **Status > H.323 Phone Status**.

Result

System Monitor displays the phones registered and how many are currently waiting to register. The **System > Print trace** filter option must be selected to see these messages.

The following appears as lines of the form:

```
792ms PRN: GRQ from c0a82c15 --- RAS reaches the maximum capacity of
10; Endpoints registered 41
```

Related links

[Connecting the phone](#) on page 55

Part 3: Optional Configuration

Chapter 9: Enabling RTCP Quality Monitoring

Avaya IP phones support call quality monitoring. Enabling RTCP monitoring provides the system with measures of packet delay, packet loss and jitter. That information can be accessed using the System Status Application and System Monitor applications. The system can also be configured to output alarms when the call quality values exceed set levels.

The RTCP call quality reports can also be sent to the address of a third-party QoS monitoring application.

For IP Office Release 10.0 and higher, in addition to having the individual phones send RTCP call quality reports the system can also send RTCP reports for calls.

Related links

[Enabling Telephone Quality Reporting](#) on page 59

[Enabling System Quality Reporting](#) on page 60

[Setting the Quality Alarm Levels](#) on page 61

Enabling Telephone Quality Reporting

About this task

Enabling RTCP call quality reporting from phones is done centrally from the system settings.

Procedure

1. Using IP Office Manager, retrieve the configuration from the system.
2. Select  **System**
3. Select the **LAN1** or **LAN2** tab depending on which of the system's LAN interfaces you want to use to support H.323 extensions.

4. Select the **VoIP** sub-tab.

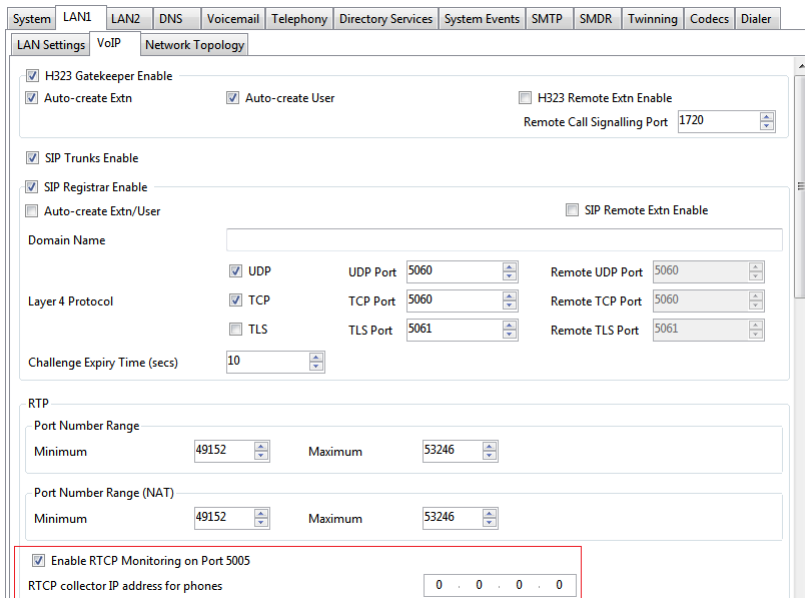

5. Enable **Enable RTCP Monitoring on Port 5005** checkbox.

By default the RTCP data is sent to the IP Office system. enter the address in the **RTCP collector IP address for phones** for phones field send data to a specific address for collection by a third-party QoS monitoring application.

6. Save the configuration.

Related links

[Enabling RTCP Quality Monitoring](#) on page 59

Enabling System Quality Reporting

About this task

For IP Office Release 10.0 and higher, in addition to having the individual phones send RTCP call quality reports , the system can also send RTCP reports for calls.

Procedure

1. Using IP Office Manager, retrieve the configuration from the system.
2. Select **System**
3. Select the **Telephony** tab and then the **Telephony** sub-tab.
4. Go to the **RTCP Collector Configuration** section.
 - a. Enable the **Send RTCP to an RTCP Collector** checkbox.

- b. In **Server Address** add the address of the third-party QoS monitoring application to which the system sends RTCP reports.
 - c. In **UDP Port Number** enter the destination port. The default is 5005.
 - d. In **RTCP reporting interval** enter how frequently the system sends RTCP reports.
5. Save the configuration.

Related links

[Enabling RTCP Quality Monitoring](#) on page 59

Setting the Quality Alarm Levels

About this task

The system can send call quality alarms to the System Status Application. It can also send the same alarms to SNMP, emails or Syslog destinations. For details of how to configure these refer to the IP Office Manager documentation. The settings below are used to set the levels which, if exceeded, cause an alarm to be sent at the end of a call.

Procedure

1. Using IP Office Manager, retrieve the configuration from the system.
2. Select  **System**
3. Select the **System Events** tab and then the **Configuration** sub-tab.

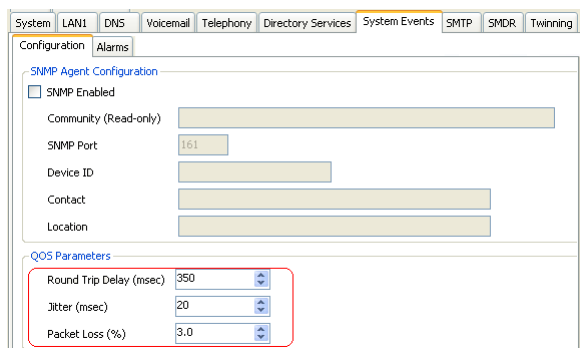

The screenshot shows the IP Office Manager configuration window with the 'System Events' tab selected. The 'Configuration' sub-tab is active, and the 'Alarms' section is expanded. The 'SNMP Agent Configuration' section includes a checkbox for 'SNMP Enabled', a 'Community (Read-only)' field, an 'SNMP Port' field with the value '161', and fields for 'Device ID', 'Contact', and 'Location'. The 'QoS Parameters' section is highlighted with a red box and contains three spinners: 'Round Trip Delay (msec)' set to 350, 'Jitter (msec)' set to 20, and 'Packet Loss (%)' set to 3.0.

The QoS Parameters are used by the system to trigger alarms. The default settings match the limits usually acceptable for good call quality.

4. Save the configuration.

Related links

[Enabling RTCP Quality Monitoring](#) on page 59

Chapter 10: Screensaver

After a set idle time, 9600 Series phones can display a screen saver image. Whilst the phone remains idle, this image is moved to another random position on the screen every 5 seconds.

For phones being fully supported by the IP Office system, a default file is automatically provided by the IP Office system by default. If otherwise:

- The timeout for the screensaver and the name of the image file are set through customizing the `46xxsettings.txt` file.
- The image file to use must be loaded onto the file server used by the phones.

The following are the image requirements

- Format: JPG images.
- Maximum Pixel Size: The image must be smaller than the screen size of the phone. If the image is larger, it will not be displayed. When several types of phones are present using the same image, the image must be below the size maximums of all the phone type. If using the `46xxsettings.txt` file to specify the screen saver settings, it is possible to specify a separate image for each phone type.

Phone	Maximum Size
9611	160X160
9621G	320X160
9614G	320X240

- Color Displays: Color depth is 16 bit. A separate color image looks best.
- Non-Color Displays: Best results are achieved with a single grayscale logo image. 2 levels of grayscale are also supported.
- Transparency: To invoke a transparent background, use a background color of 0,255,0 (brightest possible green).

The default IP Office settings use an image file called `96xxiposs.jpg`. Using the embedded file manager within IP Office Manager, replace the existing file in the system's `/primary` folder with your custom image. Reboot the phones in order for them to load the new image.

Related links

[Customizing screen saver settings](#) on page 63

Customizing screen saver settings

About this task

Default operation uses the single image `96xxiposs.jpg` which you can replace with your own image. If using a customized `46xxsettings.txt` file, you can implement set the idle timeout for displaying the screensaver and the image name.

Procedure

1. Create a customer JPG file meeting the requirements.

For this example we used the file name `logo.jpg`.

2. Download the current `46xxsettings.txt` file from the file server being used by the phones.
3. Add the following lines to the `46xxsettings.txt` file:

```
## SET SCREENSAVER filename
SET SCREENSAVER logo.jpg
## SET SCREENSAVERON time in minutes before activating
SET SCREENSAVERON 40
```

- Using Separate Images for Each Phone Type

Added the above to the start of the file affects all types of phone. Adding different settings to each of the different MODEL4 sections of the file for each phone type allows separate images to be used for each phone type.

4. Upload the new files to the file server used by the phones.
5. Reboot the phones in order for them to load the new settings and image.

Related links

[Screensaver](#) on page 62

Chapter 11: Backup/Restore Settings

1600 and 9600 Series H.323 IP Telephones support using an HTTP server as the location to which they can backup and restore user-specific data. The address for this backup server is set separately from that of the file server used for phone firmware.

These options are used if the location of the HTTP server for backup/restore has been specified in the phone `46xxsettings.txt` file.

- The address of the HTTP server for backup/restore operation is separate from the address of the HTTP server used for phone firmware files downloads.
- The HTTP server being used for backup/restore will require configuration changes to allow the phones to send files to it.
- If the IP Office system is being used as the file server for phone installation, it can also be used for the phone backup and restore functions. That includes file auto-generation . When using auto-generation, some settings within the restore file are based on the user's IP Office settings. This is therefore the recommended solution where possible.

Backup is used when the phone user logs out of the phone. During the log out process, the phone creates a file containing the user specific data and sends that to the BRURI location. The file is named with the user's extension number as a prefix to `_16xxdata.txt`; for example, `299_16xxdata.txt`.

Restore is used when a user logs in at the phone. The phone sends a file request for the appropriate file based on the user's extension number. If the file is successfully retrieved the phone will import the settings and, after a `Retrieval OK` message, continue as normal. If the file cannot be retrieved, a `Retrieval failed` message is displayed and the phone will continue with its existing settings.

Related links

- [Specifying the BRURI Value](#) on page 65
- [HTTP Authentication](#) on page 65
- [Manual Backup/Restore Control](#) on page 66
- [Example File](#) on page 66

Specifying the BRURI Value

About this task

If you are using the IP Office system as the file server it is recommended that you also use it as the backup and restore server. This option requires no additional configuration. If there is no `46xxsettings.txt` file on the IP Office system, it will auto-generate the file when it is requested by a phone and will include its own IP address as the backup/restore server address. If there is a `46xxsettings.txt` file on the IP Office system, you can edit the backup/restore server address manually using the process below to set it to match the system's IP address.

If you want to use another server, edit the `BRURI` value in the `46xxsettings.txt` file. You will also need to ensure that the server being used is configured to allow the uploading of files to the specified folder on the server.

Procedure

1. Open the `46xxsettings.txt` file.
2. Locate the line containing the **SET BRURI** value.
3. If the line is prefixed with `#` characters, remove those and any spaces.
4. After `SET BRURI`, enter a space and then the address of the HTTP backup server:
 - For example `SET BRURI http://192.168.0.28`
 - If necessary, specify the path to a specific server directory and/or include a specific port number; for example: `SET BRURI http://192.168.0.28/backups:8080`.

Related links

[Backup/Restore Settings](#) on page 64

HTTP Authentication

HTTP Authentication can be supported. If set it will be used for both the backup and the restore operations. The authentication credentials and realm are stored in the phone's programmable, non-volatile memory, which is not overwritten when new firmware is downloaded.

Both the authentication credentials and realm have a default value of null. If the HTTP server requires authentication, the user is prompted to enter new credentials using the phone. If the authentication is successful, the values used are stored and used for subsequent backup and restore operations.

Related links

[Backup/Restore Settings](#) on page 64

Manual Backup/Restore Control

Users can request a backup or restore using the **AdvancedOptions** Backup/Restore feature as detailed in the user guide for the specific telephone model.

Related links

[Backup/Restore Settings](#) on page 64

Example File

The following is an example of a backup/restore file for a 1600 Series phone user. Note that values are not written unless the setting has been changed from its default.

If the backup and restore is being done using file auto-generation, those items indicated by * are controlled by values stored and supplied by the user's IP Office settings.

```
ABKNAME001=Extn201
ABKNUMBER001=201
ABKNAME002=Extn201ad
ABKNUMBER002=201
ABKNAME003=Extn203
ABKNUMBER003=203
Redial=0
Call Timer=0
Visual Alerting=1
Call Log Active=1
Log Bridged Calls=1
Log Line Calls=1
Log Calls Answered by Others=0
Audio Path=2
Personalized Ring=7
Handset AGC=1
Headset AGC=1
Speaker AGC=1
Error Tone=1
Button Clicks=0
Display Language=English
```

Fields	Description
ABKNAMEmmm ABKNUMBERmmm	These paired entries are used for personal contacts entered into the phone. The mmm value in each pair is replaced by a 3-digit number starting with 001. The first line of the pair stores the contact name, the second line stores the phone number for the contact.*
LANGUSER	Display language. The language name is stored.*
LOGACTIVE	Call log active on (1) or off (0).*
LOGBRIDGED	Log bridged calls on (1) or off (0).*
LOGLINEAPPS	Log line calls on (1) or off (0).*
LOGOTHERANS	Log calls answered by others on (1) or off (0).*

Table continues...

Fields	Description
OPTAGCHAND	Handset Automatic Gain Control on (1) or off (0).
OPTAGCHEAD	Headset Automatic Gain Control on (1) or off (0).
OPTAGCSPKR	Speaker Automatic Gain Control on (1) or off (0).
OPTAUDIOPATH	Audio Path.*
OPTCLICKS	Button Clicks on (1) or off (0).*
OPTERRORTONE	Error Tone on (1) or off (0).*
PERSONALRING	Personalized Ring. A numeric value (1 to 8) for the selected ring is stored.*
PHNRDIAL	Redial
PHNSCRONCALL	Go to call screen on calling on (1) or off (0).
PHNSCRONALERT	Go to call screen on ringing on (1) or off (0).
PHNTIMERS	Call Timer on (1) or off (0).
PHNVISUALALERT	Visual alerting on (1) or off (0).

Related links

[Backup/Restore Settings](#) on page 64

[Configuring IIS server](#) on page 67

[Configuring apache server](#) on page 68

Configuring IIS server

About this task

Create a backup folder under the root directory of your web server. All backup files will be stored in that directory. For example, if your backup folder is `C:/inetpub/wwwroot/backup`, the `46xxsettings.txt` file should have a line similar to `SET BRURI http://www.example.com/backup`.

Procedure

1. Go to **Start > Settings > Control Panel > Administrative Tools** and select, depending on the Windows version, **Internet Information Services Manager** or **Internet Information Services**.
2. Right-click on the folder created for backup. Right-click on **Default Web Site** if there is no specific backup directory.
3. Select **Properties**.
4. In the **Directory** tab, enable **Write** checkbox.
5. Follow this procedure to configure IIS 6.0 are:
 - a. Go to **Start > Settings > Control Panel > Administrative Tools**.
 - b. Below **Default Web Site**, select **Web Services Extension**
 - c. Ensure that the **WebDAV** option is set to **Allowed**.

Related links

[Example File](#) on page 66

Configuring apache server

About this task

Create a backup folder under the root directory of your Web server. Make the folder writable by everyone. All backup files will be stored in that directory. For example, if the backup folder is `C:/Program Files/ApacheGroup/Apache2/htdocs/backup`, the `46xxsettings.txt` file should have a line similar to `SET BRURI http://www.example.com/backup`.

Before you begin

Procedure

1. Edit your Web server configuration file `httpd.conf`.
2. Uncomment the two `LoadModule` lines associated with DAV:
 - `LoadModule dav_module modules/mod_dav.so`
 - `LoadModule dav_fs_module modules/mod_dav_fs.so`

Note:

If these modules are not available on your system (typically the case on some Unix/Linux Apache servers), you have to recompile these two modules (`mod_dav` & `mod_dav_fs`) into the server. Other ways to load these modules might be available. Check your Apache documentation at <http://httpd.apache.org/docs/> for more details.

3. Add the following lines in the `httpd.conf` file:

```
#
#WebDAV configuration
#D
avLockDB "C:/Program Files/Apache Group/Apache2/var/DAVLock"
<Location />
Dav On
</Location>
```

Note:

For Unix/Linux Web servers the fourth line might look more like: `DavLockDB/usr/local/apache2/var/DAVLock`

4. Create the `var` directory and make it writable by everyone. Right-click **Properties** and select **Security > Add > Everyone > Full Control > .**

Related links

[Example File](#) on page 66

Part 4: Advanced Installation Processes

Chapter 12: Static Address Installation

Static addressing is only necessary when a DHCP server is unavailable or not desired. For ease of maintenance and installation, ensure that a DHCP server is used and avoid static addressing. Following any boot file upgrade of the phone's firmware, static address information may require re-installation.

Related links

- [Installing static address for 1600 series phones](#) on page 70
- [Static address installation settings for 1600 phone series](#) on page 71
- [Installing static address for 9600 series phones](#) on page 71
- [Static address installation settings for 9600 phone series](#) on page 72

Installing static address for 1600 series phones

Procedure

1. Complete the phone connection procedure and when `DHCP` is displayed press `*` to switch the phone to static address installation.
The phone displays sequence of settings and the existing value for each of those settings.
2. To accept the existing values, press `#` or enter a value and then press `#`. See [Static address installation settings for 1600 phone series](#) on page 71.

 **Note:**

If no values are changed, the phone displays `No new values`.

3. If the phone displays `Enter power off the phone and on again`.
Once all the values are entered or the existing values accepted the phone displays `Save new values?`.
4. Press `#` to save the values.

Next steps

Register the phone.

Related links

- [Static Address Installation](#) on page 70

Static address installation settings for 1600 phone series

Settings name	Description
Phone	This is the phone's IP address. To accept the current value, press # or enter a value and then press #. If entering a new value, press the * key to enter a '.' character between digits.
CallSv	This is the address of the H.323 gatekeeper. For IP Office systems this is the IP address of the IP Office LAN.
CallSvPort	This is the Gatekeeper transport layer port number. For Avaya IP phones the value used should be 1719. To accept the current value, press # or enter a value and then press #.
Router	This is the address of the phone's default IP gateway. For IP Office this is typically the IP address of the IP Office LAN. To accept the current value, press # or enter a value and then press #.
Mask	This is the phone's IP Mask (also called the subnet mask). The mask is used with the IP address to indicate the phone's subnet. This should match the IP mask set for the IP Office Unit.
FileSv	This is the address of the file server from which the phone should request software and settings files. Enter the address of the TFTP or HTTP configured with the Avaya IP phone software file set.
802.1Q	To change the setting press *. Press # to accept the value.
VLAN ID	For details of VLAN configuration see VLAN and IP Phones .

Related links

[Static Address Installation](#) on page 70

Installing static address for 9600 series phones

Procedure

1. When * to program is displayed, press the * key.
2. When Enter code is displayed, enter the administrative procedures passcode and press #. The default passcode is CRAFT (27238).
3. Scroll the menu to ADDR and select this option to start the address procedure.
The list of required addresses is displayed. If any existing phone values is displayed. Otherwise if the phone is new or has been cleared, all the addresses are set to 0.0.0.0.
4. Set each address highlight the value to change and click **Change**. See static address installation settings.
5. Enter the new address value and then select **Save**.
6. When all the values are set as required click **Back** and click **Exit**.

The phone restarts using the new values.

Next steps

Register the phone.

Related links

[Static Address Installation](#) on page 70

Static address installation settings for 9600 phone series

Settings name	Description
Phone	This is the phone's IP address. To accept the current value, press # or enter a value and then press #. If entering a new value, press the * key to enter a '.' character between digits.
Call Server	This is the address of the H.323 gatekeeper. For IP Office systems this is the IP address of the IP Office LAN.
Router	This is the address of the phone's default IP gateway. For IP Office this is typically the IP address of the IP Office LAN. To accept the current value, press # or enter a value and then press #.
Mask	This is the phone's IP Mask (also called the subnet mask). The mask is used with the IP address to indicate the phone's subnet. This should match the IP mask set for the IP Office Unit.
HTTP File Server	This is the address of the HTTP file server from which the phone should request software and settings files.
HTTPS File Server	This is the address of the HTTPS file server from which the phone should request software and settings files. The phone will attempt to use this address, if set, before using HTTP.
802.1Q	To change the setting press *. Press # to accept the value.
VLAN ID	For details of VLAN configuration see VLAN and IP Phones .
VLAN Test	When using VLAN, this is the time in seconds the phone will wait from a response from the DHCP server in the VLAN before falling back to normal non-VLAN operation.

Related links

[Static Address Installation](#) on page 70

Chapter 13: Remote H.323 Extensions

For IP Office Release 8.0+, the configuration of remote H.323 extensions is supported without needing those extensions to be running special VPN firmware. This option is intended for use in the following scenario:

- The customer LAN has a public IP address which is forwarded to the IP Office system. That address is used as the call server address by the H.323 remote extensions.
- The user has a H.323 phone behind a domestic router. It is assumed that the domestic router allows all outbound traffic from the home network to pass through and allows all symmetric traffic. That is, if the phone sends RTP/RTCP to a public IP address and port, it will be able to receive RTP/RTCP from that same IP address and port. Configurations otherwise are not covered by this documentation.

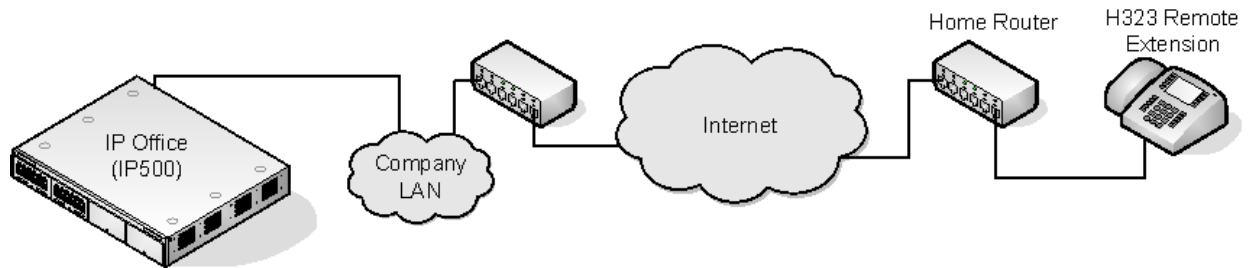

- The system can be configured to support remote H.323 extensions in the case where NAT is used in the connection path. This could be the case where the IP Office is located behind a corporate NAT/Firewall router and/or the H.323 phone is located behind residential NAT enable router. The use of this option and the interaction and configuration of external third party elements is beyond the scope this help file.
- When the public IP address of the corporate router is unknown, you need to configure a STUN server in the the IP Office LAN's Network Topology settings. Note however that this option is not supported if the Firewall/NAT Type is set to Symmetric Firewall or Open Internet.
- Enabling the Allow Remote Extn option also makes visible the configuration of the RTP Port number Range (NAT) settings.
- Supported Telephones: Currently, remote H.323 extension operation is only supported with 9600 Series phones already supported by the IP Office system.
- License Requirements: By default, only 4 users can be configured for remote H.323 extension usage without needing licenses. Additional users can be configured if those additional users are licensed and configured with either **Teleworker** or **Power User** user profiles.

Related links

[Customer Network Configuration](#) on page 74

[Configuring IP Office System](#) on page 75

[Phone Configuration](#) on page 76

Customer Network Configuration

The corporate LAN hosting the IP Office system requires a public IP address that is routed to the LAN interface of the IP Office system configured for remote H.323 extension support.

STUN from the IP Office system to the Internet is used to determine the type of NAT being applied to traffic between the system and the Internet. Any routers and other firewall devices between the H.323 phone location and the IP Office system must allow the following traffic.

Protocol	Port	Description
ICMP	-	Incoming ICMP to the IP Office system's public IP address must be allowed.
UDP	1719	UDP port 1719 traffic to the IP Office system must be allowed. This is used for H225 RAS processes such as gatekeeper discovery, registration, keepalive, etc. If this port is not open the phone will not be able to register with the IP Office system.
TCP	1720	TCP port 1720 traffic must be allowed. This is used for H.225 (call signalling). The address used can be adjusted using the Remote Call Signaling Port setting.
RTP	Various	The ports in the range specified by the system's RTP Port Number Range (NAT) settings must be allowed.
RTCP		
UDP	5005	If the system setting Enable RTCP Monitoring on Port 5005 has been enabled, traffic on this port must be allowed to include remote H.323 extensions in the monitoring.

User Network Configuration

It is assumed that the domestic router allows all outbound traffic from the home network to pass through and allows all symmetric traffic. That is, if the phone sends RTP/RTCP to a public IP address and port, the router allows it to receive RTP/RTCP from that same IP address and port.

Related links

[Remote H.323 Extensions](#) on page 73

Configuring IP Office System

About this task

This is a summary of the necessary IP Office system configuration changes. This section assumes that you are already familiar with IP Office system and H.323 IP telephone installation

Before you begin

If more than 4 remote extension users are to be supported, the system must include available **Teleworker** and or **Power User** licenses for those users.

Procedure

1. In the **System** tab configure the following:

- a. Go to **System > LAN1 > LAN2 > VoIP**.
- b. Enable the **H323 Gatekeeper Enable** checkbox.

 **Note:**

Due to the additional user and extension settings needed for remote H.323 extension configuration, the extension and user entries for the remote H.323 extensions and users are added manually.

- c. Enable **H.323 Remote Extn Enable**.
- d. Enter the required value in **Remote Call Signaling Port**.
The default value 1720 also matches the port used by internal extensions.
- e. Set **RTP Port number Range (NAT)** to encompass the port range that should be used for remote H.323 extension RTP and RTCP traffic.

 **Note:**

The range setup must provide at least two ports per extension being supported.

2. In **Network Topology** tab configure the following:

 **Note:**

STUN can be used to determine the type of NAT/firewall processes being applied to traffic between the IP Office system and the Internet.

- a. Go to **Network Topology** and set **STUN Server IP Address** to a known STUN server.
- b. Click **OK**
The **Run STUN** button is enabled.
- c. Click **Run STUN** and wait while the STUN process is run.
The results discovered by the process is indicated by ! icons next to the fields.
- d. If STUN reports the **Firewall/NAT Type** the network must be reconfigured.

 **Note:**

Static Port Block, Symmetric NAT or **Open Internet** network types are not supported for remote H.323 extensions.

3. In **User** tab configure the following:
 - a. Go to the **User** tab set the **User Profile** to **Teleworker** or **Power User**.
 - b. Enable **Enable Remote Worker**.

Related links

[Remote H.323 Extensions](#) on page 73

Phone Configuration

The phones do not require any special firmware. Therefore, they should first be installed as normal internal extensions, during which they will load the firmware provided by the IP Office system.

Once this process has been completed, the address settings of the phone should be cleared and the call server address set to the public address to be used by remote H.323 extensions.

It is assumed that at the remote location, the phone will obtain other address information by DHCP from the user's router. If that is not the case, the other address setting for the phone will need to be statically administered to match addresses suitable for the user's home network.

Related links

[Remote H.323 Extensions](#) on page 73

Chapter 14: VPN Remote Phones

Avaya IP phones at remote locations can be connected to the IP Office system via IPSec VPN tunnels. This is supported for 4610SW, 4621SW, 5610SW and 5621SW phones. It is also supported for 9600 Series phones.

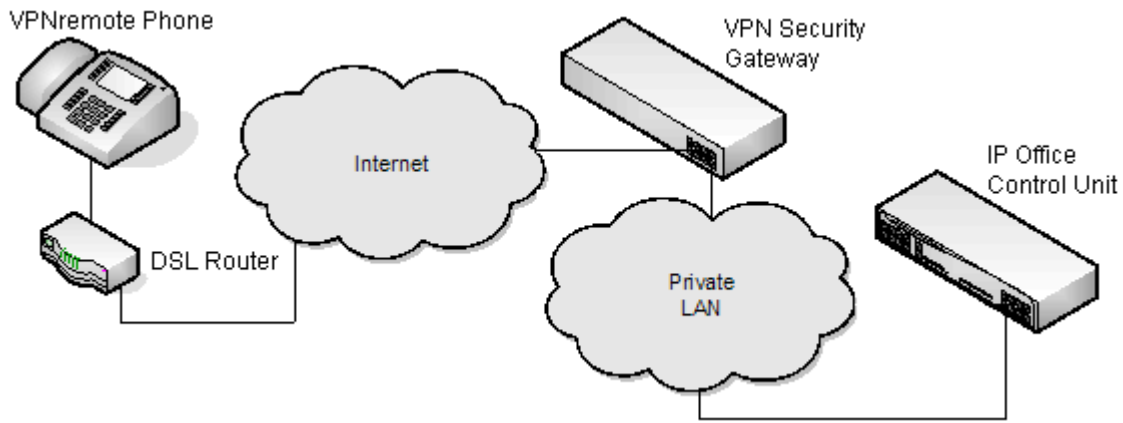

Additional components required for remote phones over VPN are:

- IP Office VPNremote Phone Firmware: This firmware is included with the IP phone firmware set.
 - VPN Security Gateway: The IP Office system does not support all the IPSec features needed for VPNremote phones using its own IPSec tunnels. Therefore the VPN tunnel from remote phones must end at a suitable alternate VPN gateway device. The device must support one of the following methods:
 - Avaya Gateways: Avaya security gateway devices (SG and VSU) use an Avaya proprietary protocol called
 - CCD Avaya SG Series (4.6 firmware or higher)
 - Avaya VSU Series (3.2 firmware or higher)
 - Non-Avaya Gateways: Non-Avaya VPN gateways with IKE Extended Authentication (Xauth) with Pre-shared Key (PSK). Installation notes exist for the items listed below. This does not imply any recommendation of those devices by Avaya or preclude other devices.
- * Note:**
- Avaya cannot guarantee support for services through non-Avaya devices.
 - Cisco VPN 300 Series Concentrators

- Cisco PIX 500 Series Security Appliances
- Juniper Networks NetScreen Series VPN Devices
- Juniper Networks Secure Services Gateway 500 Series
- Juniper Networks Integrated Security Gateway (ISG) Series
- Kentrox Q2300 VPN Router
- Sonicwall Tz170 VPN Router
- Netgear FVS338 VPN Router
- Netgear FVX538 VPN Router
- Adtran Netvanta 3305 VPN Router

Related links

[Installation Documentation](#) on page 78

[Supported VPN remote Phone Firmware](#) on page 78

[Configuring the IP Phone for VPN remote](#) on page 79

[VLAN and IP Phones](#) on page 79

[VLAN and DHCP](#) on page 80

[Example setup - Overview](#) on page 81

[Example System Overview](#) on page 84

Installation Documentation

This document only covers notes and differences specific to installation of VPNremote phones with IP Office. Then installation and configuration of Avaya VPNremote phones is covered in a number of existing documents available from the Avaya support website (<http://support.avaya.com>). Refer to *VPN Setup Guide for 9600 Series IP Telephones* doc reference 16-602968.

Related links

[VPN Remote Phones](#) on page 77

Supported VPN remote Phone Firmware

Unless otherwise advised, only the firmware provided on the IP Office Administrator Applications DVD should be used for VPNremote phones connected to an IP Office. That firmware is tested with the IP Office release for correct operation. The firmware is located in a zip file in the folder `\bin\VPN Phone`.

Whilst other VPNremote firmware releases may be made available by Avaya for download, those firmware release may not have been specifically tested with IP Office.

Related links

[VPN Remote Phones](#) on page 77

Configuring the IP Phone for VPN remote

About this task

In addition, a VPN Phone Allowed checkbox option is present on the **Extension > VoIP** settings tab of IP extensions. The **VoIP** checkbox is used to indicate to the IP Office the extensions that are VPNremote and therefore require use of a license.

Procedure

1. Using IP Office Manager, retrieve the configuration from the system.
2. Click  **Extension** and select the entry for the IP extension.
3. Select **VoIP** tab.
4. Enable **VPN Phone Allowed**.
5. Click **OK**.
6. Repeat this for any other existing IP extensions that are going to be converted to VPN connection.
7. Save the configuration.

Related links

[VPN Remote Phones](#) on page 77

VLAN and IP Phones

The use of VLAN allows separate collision domains to be created on Ethernet switches. In the case of IP Office and IP Phones the advantages are:

- It allows PCs to continue in the same IP subnet while IP Phones can use a new and separate IP addressing scheme.
- Broadcast traffic is not propagated between the PC data network and the IP Phones voice network. This helps performance as otherwise broadcast traffic must be evaluated by all receivers.
- VLAN networking and traffic prioritization at layer 2 are closely bound together in the same 802.2 standard. It is therefore easier to maintain L2 QoS when using a VLAN.

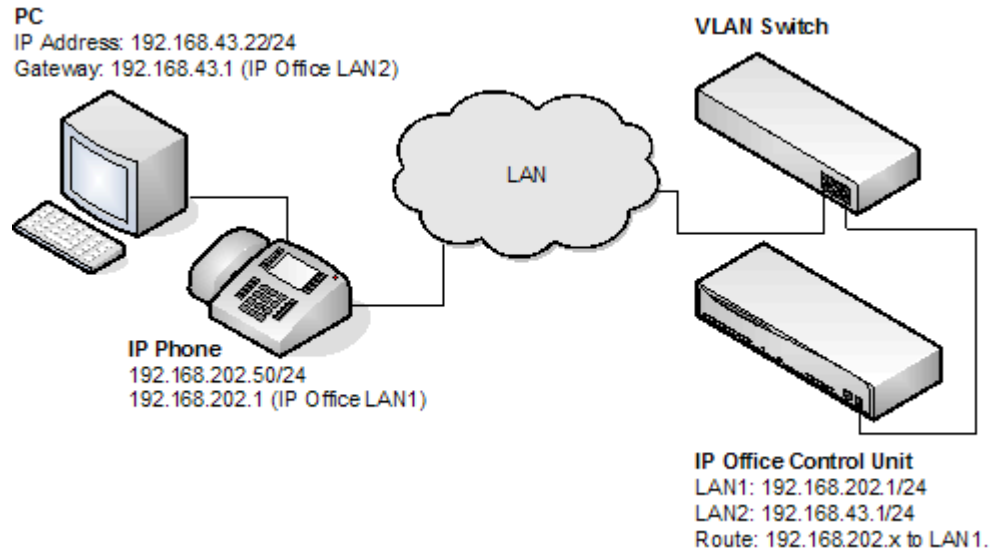

The table shows the three ways in which VLAN can be deployed with an Ethernet Switch. The first two methods require only elementary configuration, and since this document assumes both PC and IP Phones share the same Ethernet port, the focus will be the third method (overlapping).

Type	Advantages	Disadvantages
No VLAN Both Voice and Data occupy the same collision domain	Simple Configuration	PC broadcast traffic adverse effect on Voice traffic. Requires two (2) ports per user; one for IP Phone and one for PC)
Physical VLAN Separate VLAN for data and voice	Simple configuration	Requires two (2) ports on switch; one for IP phone and one for PC
Overlapping VLAN A single port on the switch carrying both the IP Phones as well as the PC traffic	Requires only a single port for both PC and IP Phone PC broadcast traffic cannot adversely effect Voice traffic	Complex configuration

Related links

[VPN Remote Phones](#) on page 77

VLAN and DHCP

The use of VLAN has implications on DHCP if DHCP is being used for support of IP phones and or PCs. The table below details the available options when using a single port for PC and IP Phones on a VLAN enabled network.

DHCP Option	Description
None (Static addressing)	Manual configuration of each IP Phone
Separate DHCP Servers	Two PCs, one for each VLAN
Multihomed DHCP Server	A single PC with two NIC Cards; one for each VLAN
DHCP Relay	The option must be supported by the Ethernet switch

If using DHCP, when the IP phone starts it first makes a DHCP request without a VLAN tag.

- If the DHCP reply contains a new VLAN setting as part of the SSON scope, the phones will release all its existing IP address and makes a new DHCP request using the newly supplied VLAN ID

If the IP Phone does not get a new VLAN ID, it will continue with the settings provided in the original DHCP reply

A VLAN ID can also be passed to a phone through the settings file that it loads. Again the IP phone will release all its existing IP parameters and then make a new DHCP request using the newly supplied VLAN ID.

In the example below, the when the IP phones receives a DHCP response from the DHCP server on the data VLAN, that response contains the VLAN ID of the voice VLAN. The phone then releases the original data VLAN settings it obtained and sends a new DHCP request to the voice VLAN.

Option	Data VLAN DHCP Settings	Voice VLAN DHCP Settings
IP Address	192.168.43.x	192.168.202.x
Mask	255.255.255.0	255.255.255.0
Router	192.168.43.1	192.168.202.1
SSON Scope	L2Q=1, L2QVLAN=202, VLANTEST=0	MCIPADD=192.168.202.1, MCPORT=1719, HTTPSRVR=192.168.202.X VLANTEST=0
The VLANTEST parameter is the length of time the IP Phone should make DHCP requests in a VLAN (0 means unlimited time).		

Related links

[VPN Remote Phones](#) on page 77

Example setup - Overview

The network is devised to allow the user PC to connect to the switch port of the IP Phone. A single cable then connects PC and IP Phone to the Ethernet Switch. For the purpose of this example, VLAN 100 is used for voice traffic and VLAN 101 is used for data traffic. The LAN1 interface of the IP Office control unit resides on the voice VLAN while the LAN2 interface resides in the data

VLAN. Communication between the voice and data VLANs is facilitated by the IP Office control unit's router function.

HP-Switch - Configuration

Shown below are the web and CLI configuration output from the HP Procurve Switch. These were obtained using the configuration guidelines found below.

VLAN ID	VLAN Name	VLAN Type	Tagged Por	Untagged Ports	Forbid Ports	Auto	
1	Native (Prim	STATIC	(STATIC) None (GVRP) None	1-2,4, 7-26	None	3,5-6	Modify
100	Red [Voice]	STATIC	(STATIC) 3 (GVRP) None	5	None	1-2,4, 6-26	Modify
101	Blue [Data]	STATIC	(STATIC) None (GVRP) None	3,6	None	1-2,4-5, 7-26	Modify

```

HP Procurve CLI output

; J8164A Configuration Editor; Created on release #H.08.60

hostname "AvayaLabs"
snmp-server community "public" Unrestricted
vlan 1
name "Native"
untagged 1-2,4,7-26
ip address 192.168.202.201 255.255.255.0
no untagged 3,5-6
exit
vlan 100
name "Red [Voice]"
untagged 5
tagged 3
exit
vlan 101
name "Blue [Data]"
untagged 3,6
exit
gvrp
spanning-tree
    
```

The table below summaries the HP configuration for ports and VLANs.

Port	VLAN 100 Voice	VLAN 101 Data	Description
3	Tagged	Untagged	<p>This port was added to both VLAN 100 and VLAN 101.</p> <p>* Note:</p> <p>When adding port 3 to VLAN 100 the Mode option must be tagged, but it must be untagged when adding to VLAN 101.</p>
5	Untagged	-	<p>This port is included only in VLAN 100 and not included in VLAN 101.</p> <p>The Mode option must be set to Untagged for port 5 in this VLAN.</p>
6	-	Untagged	<p>Port 6 is included only in VLAN 101 and not included in VLAN 100.</p> <p>The Mode option MUST be set to Untagged in this VLAN.</p>

The operation of this network is dependant on the functionality defined in HP documentation. Specifically, HP refers to this type of VLAN operation as **Overlapping VLAN**.

Related links

[VPN Remote Phones](#) on page 77

Example System Overview

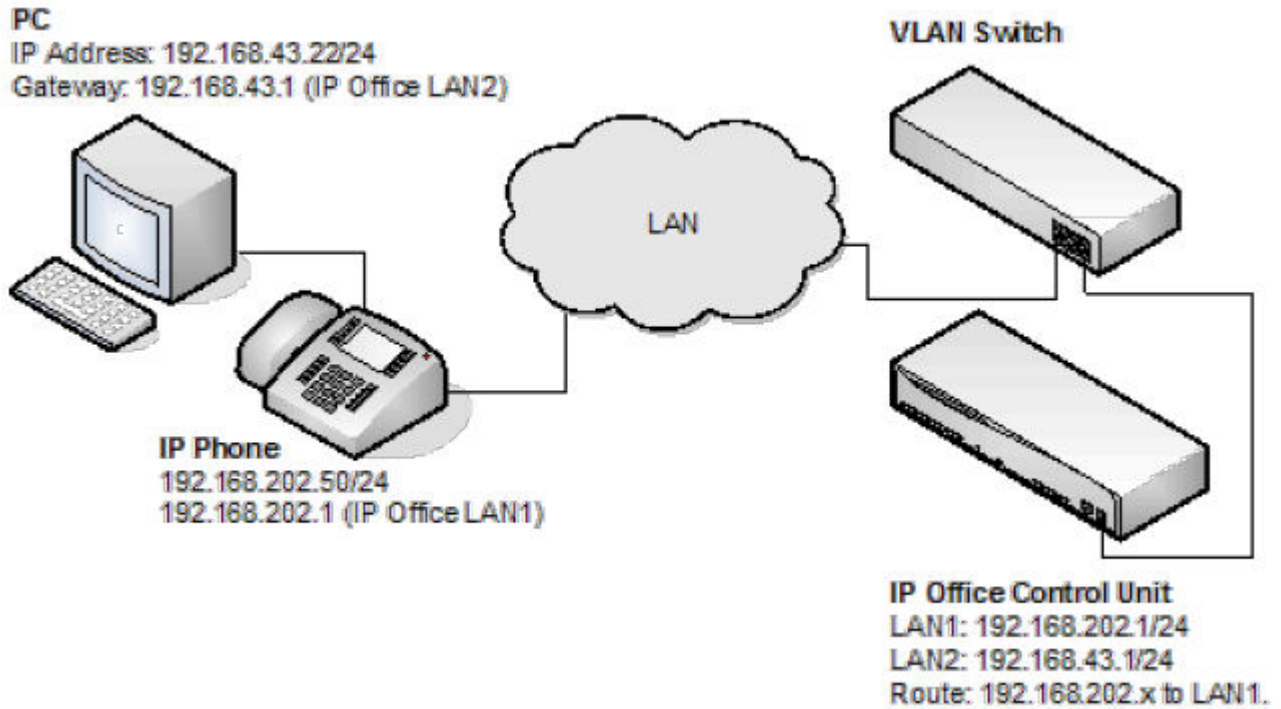

- IP Office Configuration: The table below details the configuration for IP Office. Additional configuration is not required by IP Office in support of 802.1 tagging.

Option	Value
IP Address LAN1	192.168.202.1
IP Mask LAN1	255.255.255.0
IP Address LAN2	192.168.43.1
IP Mask LAN2	255.255.255.0
Router	192.168.202.1
Call Server	192.168.202.1

- IP Phone- Configuration: In the example below, the IP phone was configured with fixed IP addressing.

Option	Value
IP Address	192.168.202.50
IP Mask	255.255.255.0
Router	192.168.202.1
Call Server	192.168.202.1
VLANID	100

- VLAN Switch Configuration: The table below summaries the HP configuration for ports and VLANs.

Port	VLAN 100 Voice	VLAN 101 Data
3	Tagged	Untagged
5	Untagged	-
6	-	Untagged

- The PC –Configuration: Shown below is the IP configuration of the PC1; no option in support of 802.1p or 802.1q is enabled on the PC.

Option	Value
IP Address	192.168.43.22
IP Mask	255.255.255.0
Router	192.168.43.1

Summary

From the port on which the PC and IP phone reside, you can receive two types of Ethernet frame (that is sent from Phone or PC):

- Tagged packets are sent by IP Phone.
- Untagged packets are sent by PC.

When an untagged packet is sent by the PC attached to the IP Phone port, it will be propagated only to VLAN 101. This is because when we added the port 3 to VLAN 101 the **Mode** option was specified as untagged. While for the other VLAN (101) the option **Tagged** was selected for port 3 in VLAN 101. Tagged packets will thereby go to VLAN 100 while the untagged will go to 101.

When a packet originates from an IP Phone it is tagged. Since the option 'untagged' is selected for port 5 in VLAN 100, the 802.1 tag is removed before the switch forwards the packet to this port. Similarly, when an untagged packet is originated and sent by the IP Office, the switch will tag the packet before forwarding LAN port 3.

Related links

[VPN Remote Phones](#) on page 77

Chapter 15: Alternate DHCP Server Setup

The recommended installation method for H.323 IP phones uses a DHCP server. This section outlines by example, the basic steps for using a Windows server as the DHCP server for IP phone installation. The principles of defining a scope are applicable to most DHCP servers.

You will need the following information from the customer's network manager:

- The IP address range and subnet mask the H.323 IP phones should use
- The IP Gateway address
- The DNS domain name, DNS server address and the WINS server address
- The DHCP lease time
- The IP address of the IP Office unit
- The IP address of the PC running Manager (this PC acts as a file server for the H.323 IP phones during installation)

Related links

[Alternate Options](#) on page 86

[Checking for DHCP Server Support](#) on page 88

[Creating a Scope](#) on page 88

[Adding a 242 option](#) on page 90

[Activating the Scope](#) on page 91

Alternate Options

In this document, all IP phone information is issued through the Scope and the Option 176 or 242 settings. Depending on the DHCP server, other options may have to be used within the scope.

Option	Description
Option 1 - Subnet mask	
Option 3 - Gateway IP Address	If using more than one address, the total list can contain up to 255 total ASCII characters. You must separate IP addresses with commas with no intervening spaces.

Table continues...

Option	Description
Option 6 - DNS server(s) Address	If using more than one address, the total list can contain up to 127 total ASCII characters. You must separate IP addresses with commas with no intervening spaces. At least one address in Option 6 must be a valid, non-zero, dotted decimal address.
Option 15 - DNS Domain Name	This string contains the domain name to be used when DNS names in system parameters are resolved into IP addresses. This domain name is appended to the DNS name before the IP telephone attempts to resolve the DNS address. Option 15 is necessary if you want to use a DNS name for the HTTP server.
Option 51 - DHCP Lease Time	<p>If this option is not received, the DHCP offer is not accepted. Avaya recommends a lease time of six (6) weeks or greater. If this option has a value of FFFFFFFF hex, the IP address lease is assumed to be infinite as per RFC 2131, Section 3.3, so that renewal and rebinding procedures are not necessary even if Options 58 and 59 are received. Expired leases cause Avaya IP Telephones to reboot.</p> <ul style="list-style-type: none"> • Provide enough leases so that an IP address for an IP telephone does not change if it is briefly taken offline. • DHCP standard states that when a DHCP lease expires, the device should immediately cease using its assigned IP address. If the network has problems and the only DHCP server is centralized, the server is not accessible to the given telephone. In this case the telephone is not usable until the server can be reached. • Once assigned an IP address, the telephone continues using that address after the DHCP lease expires, until a conflict with another device is detected. The 1600 Series IP Telephone customizable parameter DHCPSTD allows an administrator to specify that the telephone either: <ul style="list-style-type: none"> - Comply with the DHCP standard by setting DHCPSTD to 1. - Continue to use its IP address after the DHCP lease expires by setting DHCPSTD to 0. This is the default. If used, after the DHCP lease expires, the telephone sends an ARP Request for its own IP address every five (5) seconds. The request continues either forever, or until the telephone receives an ARP Reply. After receiving an ARP Reply, the telephone displays an error message, sets its IP address to 0.0.0.0, and attempts to contact the DHCP server again.
Option 52 - Overload Option	If this option is received in a message, the telephone interprets the name and file fields in accordance with IETF RFC 2132, Section 9.3, listed in Appendix B: Related Documentation.
Option 53 - DHCP Message Type	Value is 1 (DHCPDISCOVER) or 3 (DHCPREQUEST).
Option 55 - Parameter Request List	Acceptable values are: 1 (subnet mask), 3 (router IP address[es]), 6 (domain name server IP address[es]), 15 (domain name), NVSSON (site-specific option number)
Option 57 - Maximum DHCP Message Size	Used by a DHCP client or server to specify the maximum size of DHCP message it is willing to accept.
Option 58 - DHCP Lease Renew Time	If not received or if this value is greater than that for Option 51, the default value of T1 (renewal timer) is used as per IETF RFC 2131, Section 4.5.

Table continues...

Option	Description
Option 59 - DHCP Lease Rebind Time	If not received or if this value is greater than that for Option 51, the default value of T2 (rebinding timer) is used as per IETF RFC 2131, Section 4.5

*** Note:**

On H.323 IP phones, any Option 66 settings will be overridden by any TFTP entry in Option 176. Using Option 66 as part of the Scope is useful if alternate Gatekeeper addresses are required in the Option 176 settings whilst keeping within the 127 character limit.

Related links

[Alternate DHCP Server Setup](#) on page 86

Checking for DHCP Server Support

Procedure

1. On the server, select **Start > Programs > Administrative Tools > Computer Management**.
2. Under **Services and Applications** in the Computer Management Tree, locate **DHCP**.
3. If DHCP is not present then you need to install the DHCP components. Refer to Microsoft documentation.

Next steps

If the DHCP server role is supported, the first stage is to create a scope of addresses for use by IP phones.

Related links

[Alternate DHCP Server Setup](#) on page 86

Creating a Scope

About this task

A DHCP scope defines the IP addresses that the DHCP server can issue in response to DHCP requests. Different scopes may be defined for different types of devices.

Procedure

1. Go to **Start > Programs > Administrative Tools > DHCP**
2. Right-click on the server and select **New > Scope**
3. The scope creation wizard will be started, click **Next**.
4. Enter a name and comment for the scope and click **Next**.

5. Enter the address range to use, for example, from 200.200.200.1 to 200.200.200.15 (remember the host part cannot be 0).
6. Enter the subnet mask as either the number of bits used or the actual mask, for example, 24 is the same as 255.255.255.0 and click **Next**.
7. You can specify addresses to be excluded. You can do this either by entering a range and click **Add**.

You can enter the range as 200.200.200.5 to 200.200.200.7

 **Note:**

You should exclude the IP Office from this range, as the DHCP Options in the IP Office should be disabled. This is only a recommendation. You can also accomplish this by leaving available addresses outside of the scopes range.

8. Click **Next**.
9. Set the lease time for addresses.

If set too large, addresses used by devices no longer attached will not expire and be available for reuse in a reasonable time. This reduces the number of addresses available for new devices. If set too short, it will generate unnecessary traffic for address renewals. The default is 8 days.
10. Click **Next**.
11. The wizard gives the option to configure the most common DHCP options. Select **Yes** and then click **Next**.
12. Enter the address of the gateway and click **Add**.
13. Click **Next**.
14. Enter the DNS domain (eg. example.com) and the DNS server addresses and click **Next**.
15. Enter the WINS server addresses and click **Add** and then click **Next**.
16. You will then be asked if you wish to activate the scope. Select **No** and then click **Next**.
17. Click **Finish**.

Result

The new scope will now be listed and the status is set to **Inactive**.

Having created the scope that will be used by the IP phones, a set of options need to be added matching the Site Specific Options Number (SSON) that the phones will use. The SSON used by 1600 and 9600 Series phones by default is 242.

Related links

[Alternate DHCP Server Setup](#) on page 86

Adding a 242 option

About this task

In addition to issuing IP address information, DHCP servers can issue other information in response to requests for different specific DHCP option numbers. The settings for each option are attached to the scope. 1600 and 9600 Series H.323 IP phones use SSON 242 to request additional information from a DHCP server. The option should include defining the address of the phone's H.323 gatekeeper (the IP Office) and the address of the HTTP file server.

Procedure

1. Right-click on the DHCP server.
2. From the pop-up menu, select **Predefined options**.
3. Select **Add**.
4. Enter the following information:
 - a. In **Name** enter `16xxOptions`.
 - b. In **Data type** enter `String`.
 - c. In **Code** enter `242`.
 - d. In **Description** enter `IP Phone settings`.
5. Click **OK**.
6. In the string value field, enter
`MCIPADD=xxx.xxx.xxx.xxx,MCPORT=1719,HTTPSRVR=yyy.yyy.yyy.yyy,HTTPDIR=z, VLANTEST=0`
 - The maximum string length is 127 characters. To reduce the length, the TFTP Server address can be specified through attaching an Option 66 entry to the Scope. See [Alternate Options](#) on page 86.

`MCIPADD=` is the H.323 Gatekeeper (Callserver) address. Normally, this is the IP Office Unit's LAN1 address. You can enter several IP addresses, separating each by a comma with no space. This allows specification of a fallback H.323 gatekeeper. The phones will wait three (3) minutes before switching to the fallback and will not switch back when the first server recovers, until the phone is rebooted.
 - `MCPORT=` the RAS port address for initiating phone registration. The default is 1719.
 - `HTTPSRVR=` the HTTP file server IP address.
 - `HTTPDIR=` the HTTP file directory where the IP phone files are located. This entry is not required if those files are in the server's root directory.
7. Click **OK**
8. Expand the server by clicking on the [+] next to it.
9. Click on the scope you just created for the 1600 and 9600 phones.

10. In the right-hand panel, right-click on the scope and select **Scope Options**.
11. In the general tab, make sure 242 is checked.
12. Verify the String value is correct and click **OK**.

Next steps

Having created a 242 option and associated with the scope we want used by the IP phones, we now need to activate the scope

Related links

[Alternate DHCP Server Setup](#) on page 86

Activating the Scope

The scope can be manually activated by right-clicking on the scope, select **All Tasks** and select **Activate**. The activation is immediate.

You should now be able to start installing H.323 IP phones using DHCP. If Manager is being used as the HTTP or TFTP server, ensure that it is running on the specified PC.

Related links

[Alternate DHCP Server Setup](#) on page 86

Chapter 16: SRTP Support

For IP Office Release 9.1, SRTP is supported.

- Support IP Office Modes: SRTP is supported in all IP Office modes.
- Supported Phones: It can be applied to SIP and H323 extensions. However, there may be restrictions for some specific models of IP telephone.
 - Supported for H323 on 9608, 9611, 9621 and 9641 Series telephones.
 - Supported for SIP on Avaya and 3rd-party telephones.
- Supported Trunks: It can be applied to all types of IP lines (SIP, SM and IP Office (SCN)) except external H323 trunks.
- Licensing and Capacity: The use of SRTP does not require any licenses or subscription. However, the use of SRTP impacts on the call capacity of the system.
 - For IP500 V2/IP500 V2A systems with IP500 VCM cards, those cards are used to support SRTP and reduce the impact on the system call capacity. This does not apply to combination cards.

Related links

[Enable System SRTP](#) on page 92

[Direct media](#) on page 94

Enable System SRTP

By default, all IP extensions and lines are configured to automatically match the top-level system settings for SRTP, whether disabled or enabled. This simplifies enabling SRTP by ensuring that all devices are using the same SRTP settings. Using this approach, once SRTP is enabled, the only device level configuration required is to disable SRTP on those lines or devices for which it is not required.

The exception to the above is SIP lines for which SRTP is disabled by default. This is due to the low number of SIP line providers who currently support SRTP. However, SIP lines can be configured to also match the system level settings if required.

Related links

[SRTP Support](#) on page 92

[Enabling system SRTP](#) on page 93

[Disabling SRTP on an extension or line](#) on page 93

Enabling system SRTP

Procedure

1. Receive the configuration from the system.
2. Click **System** and select the **VoIP Security** tab.
3. For **Media Security**, select the level of STRP operation required:

Setting	Description
Disabled	STRP is not used for connections.
Best Effort	Support both RTP and SRTP. Use SRTP if matching SRTP settings can be negotiated with the remote end. This requires the remote end to support srtp rfc5939 (capability negotiation for SRTP). Otherwise use RTP. Note that E129 phones does not support Best Effort .
Enforced	Use SRTP only. The call is not allowed if the remote leg does not support matching SRTP.
Advanced Settings	After selecting either Best Effort or Enforced as the STRP method, it is recommended that all other SRTP settings are left at their defaults. The default SRTP flags and crypto suite settings were chosen so that they work with all Avaya H323 and SIP devices. For example, the majority of Avaya implementations don't support RTCP encryption and Avaya H323 phones only support the SHA_80 crypto suite.

4. Click **OK**.

Related links

[Enable System SRTP](#) on page 92

Disabling SRTP on an extension or line

Procedure

1. Click on **Extension** or **Line** and select the required extension or line.
2. Select the **VoIP** tab.
3. Change the **Media Security** setting to **Disabled**.
4. Click **OK**.

Next steps

Repeat for any other extension or line for which SRTP should not be used.

Related links

[Enable System SRTP](#) on page 92

Direct media

If direct media is configured, the system tries to negotiate direct media between the call ends. When SRTP is involved, addition to checking for matching VoIP criteria (for example matching codec support), the system also checks for matching Media Security and media security advanced settings (SRTP flags and crypto suites). Any incompatibility prohibits the call using direct media.

Calls between call legs set to different **Media Security** levels (**Disabled**, **Best Effort** or **Enforced**) will not use direct media.

Related links

[SRTP Support](#) on page 92

Chapter 17: TLS Support

For IP Office Release 10 and higher, it is possible to use TLS for the connection of 9600 telephones. When enabled, TLS is used for the TCP RAS and call signalling between the telephone and the IP Office system.

- Supported with the 9608, 9611, 9621 and 9641 models.
- Requires the phone to be running 6.6029 firmware or higher.
- Requires the telephone to use a non-default CRAFT password.
- The use of TLS by the system can be set as either optional or enforced.

Process Summary

1. Customize the Craft process password
2. Add the identity certificate
3. Enable TLS on the IP Office system
4. Enable TLS on the telephone

Additional Notes

For phones using TLS:

- HTTPS file server connection uses port 8411. File server need same certificate.
- If remote and also using SRTP, the telephone uses port 8443 for backup/restore.

Related links

[Changing the CRAFT Password](#) on page 96

[Adding the Identity Certificate](#) on page 96

[Downloading the identity certificate from a Linux based server](#) on page 97

[Uploading a certificate to the server's trusted certificate store](#) on page 97

[Enabling TLS on the IP Office](#) on page 98

[Enabling TLS on the telephone](#) on page 98

[Checking TLS Operation](#) on page 99

Changing the CRAFT Password

About this task

The phone's TLS operation setting cannot be changed enabled if the telephones are using the default CRAFT process password. The password can be changed as follows:

Procedure

1. If the telephones are downloading a `46xxsettings.txt` file from a file server do the following:
 - a. Add a **SET PROCPSWD** entry to the `46xxsettings.txt` file followed by the password that should be used.
 - b. Reboot the phones to load the new settings.
2. If the telephones are using the IP Office auto-generated settings:
 - a. Receive the IP Office configuration and locate the **NoUser** user.
 - b. In the **Source Numbers** tab, add **SET_46xx_PROCPSWD** followed by the new password.

Note that the command is case sensitive.
 - c. Save the configuration and reboot the system.
3. To view the auto-generated file setting:
 - a. Open browser and enter `http://<server_address>/46xxsettings.txt`.
 - b. In file include a line starting **SET PROCPSWD** followed by the new password.

Related links

[TLS Support](#) on page 95

Adding the Identity Certificate

By default the IP Office root certificate is used. For an IP500 V2 this is its own self-signed security certificate and no further changes are required. For Linux based servers, it is necessary to download the server's own self-signed certificate and then load that certificate into the IP Office service's trusted certificate store.

To use a third-party certificate, that certificate needs to be uploaded to the IP Office's trusted certificate store.

The telephone is informed about which certificate to use by setting in the `46xxsettings.txt` file it receives. The following settings are used:

- `SET TLSSRVVERIFYID 1`: This setting instructs the telephone to verify the TLS certificate.
- `SET TRUSTCERTS Root-CA-xxxxxxxx.pem`: This setting indicate the name of the security certificate that the telephone should request and load when starting.

When the IP Office receives a request for a certificate, it searches its trusted certificate store. If bytes 13-16 of the Public key of the root CA match the xxxxxxxx of the filename in the request, then IP Office provides the root CA as an auto-generated file named `Root-CA-xxxxxxx.pem`.

For systems using auto-generated files, the settings are added automatically. For other installation, the settings must be manually added to the section of the 46xxsettings file intended for 9608, 9611, 9621 and 9641 telephones.

Related links

[TLS Support](#) on page 95

Downloading the identity certificate from a Linux based server

About this task Procedure

1. Browse to https://%3Cserver_address%3E:7071 and login to the server's web control menus.

Alternatively, login to the server's web management menus and then select **Platform View**.

2. Select the **Settings** tab and then select **General**.
3. Locate the **Certificates** section.
4. In the **Certified Authority Settings** section, click **Download (PEM-Encoded)**.

Related links

[TLS Support](#) on page 95

Uploading a certificate to the server's trusted certificate store

Procedure

1. Start IP Office Manager.
2. Select **File > Advanced > Security Settings**
3. Select the server and login.
4. Select **System**.
5. Select the **Certificates** tab.
6. In the **Trusted Certificate Store** section, click **Add**.

Related links

[TLS Support](#) on page 95

Enabling TLS on the IP Office

About this task

The IP Office system can use a number of TLS options.

Procedure

1. Using IP Office Manager, load the server's configuration.
2. Select **System**.
3. Select **LAN1** or **LAN2** tab as appropriate and then select the **VoIP** tab.
4. The TLS operation is controlled by the **H.323 Signalling over TLS** field. Select the TLS mode required:
 - **Disabled**: Do not use TLS. Phones configured for TLS fallback to normal TCP connection.
 - **Preferred**: Use TLS with telephones configured for TLS but also allow normal TCP connections from other telephones.
 - **Enforced**: Require TLS. Refuse connections from telephones not configured for TLS. Note that when this option is selected, the **Remote Call Signaling Port** is fixed to 1300.
5. Click **OK**.
6. Save the configuration changes and allow the system to reboot.

Related links

[TLS Support](#) on page 95

Enabling TLS on the telephone

About this task

The TLS setting for the telephone is accessed through its Debug menu.

Note:

When existing telephones upgrade to TLS capable firmware, the H.323 signalling over TLS setting defaults to on. However, with systems not configured for TLS operation the telephones fallback to using TCP connection.

Procedure

1. Press **MUTE** followed by CRAFT process password and #.

The menu can be accessed on phones using the default CRAFT process password. However, in that case you can only view the settings, you cannot change them.

2. Scroll to and select **DEBUG**.
3. Scroll to **H.323 Signalling over TLS**.
4. Change the setting as required.
5. Click **Save**.
6. Click **Exit**.

Result

The phone is restarted using the new setting.

Related links

[TLS Support](#) on page 95

Checking TLS Operation

The use of TLS can be checked and confirmed as follows.

- System Status Application: The **Extension** details indicate the **Layer 4 Protocol** being used by the extension connection. **TLS** is shown when TLS is used.
- System Monitor: Within monitor, select **Status > H323 Phone Status**. The **Transport** column shows **TLS** for extensions using TLS for their connection.

Within monitor traces, H323 RAS Tx and Rx records indicate whether they are using TLS. Similarly, H323 CS and RAS records show the use of port 1300.

Related links

[TLS Support](#) on page 95

Part 5: Miscellaneous

Chapter 18: Static Administration Options

A number of settings can be altered through the phone after installation. These procedures should only be used if you are using static address installation. Do not use these procedures if you are using DHCP except if you are attempting to reassign a phone that has been previously statically installed.

To set parameters for all H.323 IP phones on a system, you can edit the `46xxsettings.txt` script file. However, values assigned through static administration override any set through the `46xxsettings.txt` file. They remain active for the IP phone until a new boot file is downloaded.

Related links

- [Using Static Administration Options](#) on page 101
- [Administrator Process Password](#) on page 103
- [Enabling hub interface](#) on page 103
- [View details of phone](#) on page 104
- [Self-test procedure for 1600 series phones](#) on page 106
- [Self-test procedure for 9600 series phones](#) on page 107
- [Resetting a phone](#) on page 107
- [Clearing a Phone](#) on page 109
- [Site Specific Option Number](#) on page 110

Using Static Administration Options

The method used to access static administration depends on the type of phone. Many of the static administration features are accessed using key sequences that begin by pressing either **MUTE** or **HOLD**. In recent firmware releases, preference has been given to using **MUTE** and some phones, for example the 1600 Series, only support **MUTE**.

Related links

- [Static Administration Options](#) on page 101
- [Entering administrative options in 1600 series phones](#) on page 102
- [Entering administrative options in 9600 series phones](#) on page 102

Entering administrative options in 1600 series phones

About this task

This section describes how to enter data for the administrative options.

Procedure

1. With the phone idle, press **MUTE**.

After pressing **MUTE**, if a valid button is not pressed within 6 seconds of the previous button the collected digits are discarded and the phone returns to idle.

2. Dial the administrative process password
3. Dial the digits for the required command followed by #.
 - Attempts to enter invalid data are rejected and the phone emits an error beep.
 - If a numeric digit is entered for a value or for a field of an IP address or subnet mask after only a zero has been entered, the new digit will replace the zero.
 - To go to the next step, press #.

Related links

[Using Static Administration Options](#) on page 101

Entering administrative options in 9600 series phones

About this task

Administrative procedures for 9600 Series phones can only be accessed by restarting the phone.

Procedure

1. While the phone is on-hook and idle, press **MUTE** <password> #.
2. Scroll the menu to the action required and select it.

When the selected procedure is finished, the phone will return to the procedures menu.

3. When all the required procedures have been completed, press **Exit**.

Result

The phone restarts with new settings.

Related links

[Using Static Administration Options](#) on page 101

Administrator Process Password

About this task

Administrative phone processes are protected by the use of a process password, also known as the CRAFT password. The password can be changed from its default by specifying the new value in the `46xxsettings.txt` file.

Procedure

1. If the telephones are downloading a `46xxsettings.txt` file from a file server do the following:
 - a. Add a **SET PROCPSWD** entry to the `46xxsettings.txt` file followed by the password that should be used.
 - b. Reboot the phones to load the new settings.
2. If the telephones are using the IP Office auto-generated settings:
 - a. Receive the IP Office configuration and locate the **NoUser** user.
 - b. In the **Source Numbers** tab, add **SET_46xx_PROCPSWD** followed by the new password.

Note that the command is case sensitive.
 - c. Save the configuration and reboot the system.
3. To view the auto-generated file setting:
 - a. Open browser and enter `http://<server_address>/46xxsettings.txt`.
 - b. In file include a line starting **SET PROCPSWD** followed by the new password.

Related links

[Static Administration Options](#) on page 101

Enabling hub interface

The hub interface is found on many Avaya IP phones which can be used for user PC connection . The hub interface is enabled by default.

Related links

[Static Administration Options](#) on page 101

[Enabling hub interface for 1600 series phones](#) on page 104

[Enabling hub interface for 9600 series](#) on page 104

Enabling hub interface for 1600 series phones

Procedure

1. While the phone is on-hook and idle, press `MUTE <password> INT #` or `MUTE <password> 468 #`.

The phones port settings are shown in sequence. The options vary between different models of phone.

- `PHY2=`

This is the PC connection LAN socket marked as  on the phone. Press 1 or 0 to enable or disable the hub interface respectively. To continue, press #.

- `IR=`

This is the infrared (IR) port located on the front of some H.323 IP phones. Press 1 or 0 to enable or disable the hub interface respectively. To continue, press #.

2. Press # to save the new values.

Result

`New values being saved` is displayed and then the set returns to normal operation.

Related links

[Enabling hub interface](#) on page 103

Enabling hub interface for 9600 series

Procedure

1. While the phone is on-hook and idle, press `MUTE <password> #`.
2. Scroll the menu to **INT**.
3. Select the port that you want to adjust. The options are **Ethernet** and **PC Ethernet**.
4. Use the < and > buttons to scroll through the port's possible settings.
The additional option **Disabled** is available for the PC Ethernet port.
5. Press **Save**.
6. Select another procedure or press **Exit** to restart the phone.

Related links

[Enabling hub interface](#) on page 103

View details of phone

You can view a number of phone details. These are in addition to the other static address and local administration options which can also be used to review settings.

Related links

[Static Administration Options](#) on page 101

[View details of 1600 series phones](#) on page 105

[Viewing details of 9600 series phones](#) on page 106

View details of 1600 series phones**Procedure**

1. While the phone is on-hook and idle, press `MUTE CRAFT VIEW #` or `MUTE 27238 8439 #`.
2. To display the details, press `*` at any time during viewing. The following settings are displayed:

Value	Description
Model	Shows the phones model number; for example, 4624D02A.
Market	Shows 1 for export or 0 for domestic (US). Not displayed on all phone types.
Phone SN	Shows the phone's serial number.
PWB SN	Shows the phone's Printed Wiring Board Serial Number .
PWB comcode	Shows the PWB's comcode.
MAC address	Shows the phone's MAC address as paired hexadecimal numbers.
L2 tagging	Indicates whether L2 tagging is on , off or set to auto .
VLAN ID	Used for the phone. The default is 0.
IP address	The IP address assigned to the phone.
Subnet mask	The subnet mask assigned to the phone.
Router	The router address assigned to the phone.
File server	The address of the file server assigned to the phone.
Call Server	The address of the phone's H.323 Gatekeeper.
802.1X	The current setting for 802.1X operation if being used.
Group	This displays the group value set on the phone. Group values can be used to control which options (both firmware and settings) a phone downloads.
Protocol	Display Default .
filename1	Shows the name of the phone application file in the phone's memory. These are values from within the boot file loaded and not the actual file name.
10Mbps Ethernet 100Mbps Ethernet	Shows the speed of the detected LAN connection.
filename2	Shows the boot file name and level. These are values from within the boot file loaded and not the actual file name.

3. To end the procedure and restore the user interface to its previous state, press `#`.

4. To display the next value press *.

Related links

[View details of phone](#) on page 104

Viewing details of 9600 series phones

Procedure

1. While the phone is on-hook and idle, press MUTE <password> #.
2. Scroll the menu to **VIEW** and start the procedure.

Value	Description
Model	Shows the phone's model number; for example, 4624D02A.
Phone SN	Shows the phone's Serial Number.
PWB SN	Shows the phone's Printed Wiring Board Serial Number .
PWB comcode	Shows the PWB's comcode.
MAC	Shows the phone's MAC address as paired hexadecimal numbers.
Group	Shows the group value set on the phone. Group values can be used to control which options (both firmware and settings) a phone downloads.
Protocol	Display Default .
Application File	Shows the name of the phone application file in the phone's memory. These are values from within the boot file loaded and not the actual file name.
Ethernet	Shows the speed of the detected LAN connection.
Boot File	Shows the boot file name and level. These are values from within the boot file loaded and not the actual file name.
Proxy Server	Shows the details of the selected proxy server.
Voice Language File	The name of the language file the phone is using. This is blank when using the phone's default language (English).

3. Press **Back**.
4. Select another procedure or press **Exit** to restart the phone.

Related links

[View details of phone](#) on page 104

Self-test procedure for 1600 series phones

Procedure

1. To start the IP phone self-test procedure, press MUTE <password> TEST # or MUTE <password> 8378 #.

The phone does the following:

- Each column of programmable button LEDs is lit for half a second from left to right across the phone, in a repeating cycle. The Speaker/Mute LED and the message waiting LED are also lit in sequence.
- Buttons (other than #) generate a click if pressed.
- Phones with displays show `Self test #=end` for 1 second after self-test is started. Then a block character (all pixels on) is displayed in all display character locations for 5 seconds. Display of the block character is used to find bad display pixels.

- If self-test passes:

```
Self test passed
#=end
```

- If self-test fails:

```
Self test failed
#=end
```

2. To end the self-test, press #.

Result

The phone returns to normal operation.

Related links

[Static Administration Options](#) on page 101

Self-test procedure for 9600 series phones

Procedure

1. While the phone is on-hook and idle, press `MUTE <password> #`.
2. Scroll the menu to **Test**.
3. Press **Test** again to confirm the action.

Related links

[Static Administration Options](#) on page 101

Resetting a phone

Resetting a phone resets all the system values and most of the system initialization values. The procedure does not affect user-specified data and settings (example Contact data, Options settings, login extension or password, and so on.). To remove all such data, refer to [Clearing a Phone](#) on page 109.

Related links

[Static Administration Options](#) on page 101

[Resetting 1600 series phone](#) on page 108

[Resetting 9600 series phone](#) on page 108

Resetting 1600 series phone

Procedure

1. While the phone is on-hook and idle, press the following sequence MUTE <password>
RESET #
MUTE <password> 73738 #

Warning:

As soon as you press #, all static information is erased without any possibility of recovering the data.

2. To continue press #.

Whilst the system values are reset to their defaults, Resetting values is displayed.

Once the system values are reset, Restart phone? is displayed.

3. To end the procedure without restarting the phone, press *.
4. To restart the phone, press #.

The remainder of the procedure then depends on the status of the boot and application files. See [Restart Senarios](#) on page 112.

Related links

[Resetting a phone](#) on page 107

Resetting 9600 series phone

Procedure

1. While the phone is on-hook and idle, press MUTE <password> #.
2. Scroll the menu and select **Reset Values**.
3. Press **Reset** to confirm the action.

Result

The phone user settings are reset as the phone restarts.

Related links

[Resetting a phone](#) on page 107

Clearing a Phone

Clearing all system initialization values back to their default settings and deleting all user-specific data is intended primarily for repair and for use when the phone is given to a new user. This returns the phone near to its original, out-of-box state. The phone will yet retain the firmware files it has already downloaded.

 **Note:**

Some parameters, such as button clicks, error tones, and personalized ringing, may be set for a specific user via the MENU. These user settings will be restored when you register the user to the phone because those parameters are configured in IP Office. All other settings (for example Contact data, Options settings, and so on.) is cleared from the phone.

Related links

[Static Administration Options](#) on page 101

[Clearing 1600 series phones](#) on page 109

[Clearing 9600 series phones](#) on page 109

Clearing 1600 series phones

Procedure

1. While the phone is on-hook and idle, press the following sequence MUTE <password>
CLEAR #.

MUTE <password> 25327 #
2. To continue press #.

 **Warning:**

As soon as you press #, all static information is erased without any possibility of recovering the data.

Whilst the system values are reset to their defaults, `Clearing values` is displayed.

Result

Once all values are cleared, the phone restarts as if it is a new phone.

Related links

[Clearing a Phone](#) on page 109

Clearing 9600 series phones

Procedure

1. While the phone is on-hook and idle, press MUTE <password> #.
- 2.
3. Scroll the menu and select **Clear**.

4. Press **Clear** again to confirm the action.

Result

The phone settings are cleared and the phone restarts.

Related links

[Clearing a Phone](#) on page 109

Site Specific Option Number

The Site Specific Option Number (SSON) is used by IP phones to request information from a DHCP server that is specific to the phones and not to other IP devices being supported by the DHCP server. The number must match a similarly-numbered 'option' set on the DHCP server that defines the various settings required by the phone.

The default SSON used by Avaya 1600 Series and 9600 Series phones is 242. For phones being supported by IP Office DHCP, the SSON used by the phone must match one of the site specific option numbers set in the IP Office configuration

Warning:

Do not perform this if using static addressing. Only perform this procedure if using DHCP addressing and the DHCP option number has been changed from the normal default.

Related links

[Static Administration Options](#) on page 101

[SSON in 1600 series phones](#) on page 110

[SSON in 9600 phone series](#) on page 111

SSON in 1600 series phones

Procedure

1. While the phone is on-hook and idle, press MUTE <password> SSON # or MUTE <password> 7766 #

SSON= is displayed followed by the current value.

2. Enter the new setting. This must be a number between 128 and 255.
3. To cancel this procedure, press * or press # to save the new value.

Related links

[Site Specific Option Number](#) on page 110

SSON in 9600 phone series

Procedure

1. While the phone is on-hook and idle, press `MUTE <password> #`.
2. Scroll the menu to **SSON** and start the procedure.
3. Enter the new SSON number that the phone should use when it next restarts.
4. Press **Save**.
5. Select another procedure or press **Exit** to restart the phone.

Related links

[Site Specific Option Number](#) on page 110

Chapter 19: Restart Senarios

The sequence of the restart process depends on the version of the phone boot file already downloaded to the phone as well as those on the file server. This appendix explains the different scenarios possible.

All of the following start-up procedures involve the same initial steps as the phone negotiates with the DHCP server and the file server.

1. After power is applied, the phone displays `Restarting` followed by `Initializing`
2. When either the application file (if there is one) or the boot code is uncompressed into RAM, `Loading` is displayed. Since this takes a while, asterisks, then periods, then asterisks are displayed on the second line to indicate that something is happening.
3. When control is passed to the code in RAM, `Starting` is displayed.
4. The phone detects and displays the speed of the Ethernet interface in Mbps (that is 10 or 100). The message No Ethernet means the LAN interface speed cannot be determined. The Ethernet speed indicated is the LAN interface speed for both the phone and any attached PC.
5. DHCP is displayed whilst the phone obtains an IP address and other information from the LAN's DHCP server. The number of elapsed seconds is incremented until DHCP successfully completes.
 - If the phone has been setup using static addressing (by pressing * when DHCP is shown), it will skip DHCP and use the static address settings it was given.
 - Note that uploading a new boot file at any time erases all static address information.
6. Once DHCP has completed successfully, the phone requests files from the file server indicated in the DHCP response. The first file requested details the other files that the phone should also load. The phone first makes its file request using HTTPS. If this fails it makes the same request using HTTP. If that fails it makes a final request using TFTP. If all requests for a file fail, the phone fallbacks to using the current version of the file it has in its own memory.
7. After the upgrade script is loaded, the sequence depends on the status of the files currently held in the phone's memory, compared to those listed in the upgrade script file.

Related links

[Boot File Needs Upgrading](#) on page 113

[No Application File or Application File Needs Upgrading](#) on page 113

[Correct Boot File and Application File Already Loaded](#) on page 114

Boot File Needs Upgrading

Having processed the upgrade script file, the software determines that the name of the boot code file in the phone does not match that in the upgrade script. The script specifies the name of the new file to load.

1. The phone displays the file name and the number of kilobytes loaded.
2. The phone displays `Saving to flash` while the new boot file is stored in its flash memory. The percentage of the file stored and the number of seconds that have elapsed are shown. This will usually take longer than it took to download the file.
3. The phone displays `Restarting` as it prepares to reboot using the new boot file.
4. The phone displays `Initializing`.
5. While the new boot file is uncompressed into RAM, the phone displays `Loading`. Since this takes a while, asterisks, then periods, then asterisks are displayed on the second line to indicate that something is happening.
6. When control is passed to the software that has just loaded, the phone displays `Starting`.
7. The phone displays `Clearing` whilst the flash memory is erased in preparation for rewriting the code. The percentage of memory erased and number of elapsed seconds are also shown.
8. Updating is displayed whilst the boot code is rewritten. The phone also displays the percentage of boot code rewritten and the number of elapsed seconds.
9. When the new boot code has been successfully written into the flash memory, the phone resets so that the status of the phone application files can be checked.

Related links

[Restart Senarios](#) on page 112

No Application File or Application File Needs Upgrading

This happens with normal application file upgrades. Having processed the upgrade script file, the software determines that the name of the boot file in the phone is the correct version. It next determines that the name of the application file does not match that stored in the phone.

1. The phone displays the required file name as it downloads the file from the TFTP server. It also displays the number of kilobytes downloaded.
2. `Saving to flash` is displayed. The phone also displays the percentage of file stored and the number of seconds that have elapsed. This will usually take longer than it took to download the file.
3. The phone is reset so that the new system-specific application file can be executed.

Related links

[Restart Scenarios](#) on page 112

Correct Boot File and Application File Already Loaded

This happens with most normal restarts. Having processed the upgrade script file, the software determines that the name of the boot file in the phone and the phone application file match those specified in the upgrade script.

1. System-specific registration with the switch is started. The phone requests the extension number it should use and the password.
 - By default, the phone displays the last extension number it used. To accept, press #.
 - Whilst a password request is shown, password verification is not performed except if the user changes the extension number.
 - The password is checked against is the extension's **Phone Password** stored in IP Office Manager. If a **Phone Password** has not been set, the system will also check the matching user's Login Code. Pre-IP Office Release 9.0 systems only use the matching user's **Login Code**.
2. Upon completion of registration, a dial-tone is available on the phone if it has also been able to obtain an extension license or user subscription.

Related links

[Restart Scenarios](#) on page 112

Part 6: Further Help

Chapter 20: Additional Help and Documentation

The following pages provide sources for additional help.

Related links

- [Additional Manuals and User Guides](#) on page 116
- [Getting Help](#) on page 116
- [Finding an Avaya Business Partner](#) on page 117
- [Additional IP Office resources](#) on page 117
- [Training](#) on page 118

Additional Manuals and User Guides

The [Avaya Documentation Center](#) website contains user guides and manuals for Avaya products including IP Office.

- For a listing of the current IP Office manuals and user guides, look at the [Avaya IP Office™ Platform Manuals and User Guides](#) document.
- The [Avaya IP Office Knowledgebase](#) and [Avaya Support](#) websites also provide access to the IP Office technical manuals and users guides.
 - Note that where possible these sites redirect users to the version of the document hosted by the [Avaya Documentation Center](#).

For other types of documents and other resources, visit the various Avaya websites (see [Additional IP Office resources](#) on page 117).

Related links

- [Additional Help and Documentation](#) on page 116

Getting Help

Avaya sells IP Office through accredited business partners. Those business partners provide direct support to their customers and can escalate issues to Avaya when necessary.

If your IP Office system currently does not have an Avaya business partner providing support and maintenance for it, you can use the Avaya Partner Locator tool to find a business partner. See [Finding an Avaya Business Partner](#) on page 117.

Related links

[Additional Help and Documentation](#) on page 116

Finding an Avaya Business Partner

If your IP Office system currently does not have an Avaya business partner providing support and maintenance for it, you can use the Avaya Partner Locator tool to find a business partner.

Procedure

1. Using a browser, go to the [Avaya Website](#) at <https://www.avaya.com>
2. Select **Partners** and then **Find a Partner**.
3. Enter your location information.
4. For IP Office business partners, using the **Filter**, select **Small/Medium Business**.

Related links

[Additional Help and Documentation](#) on page 116

Additional IP Office resources

In addition to the documentation website (see [Additional Manuals and User Guides](#) on page 116), there are a range of website that provide information about Avaya products and services including IP Office.

- [Avaya Website](#) (<https://www.avaya.com>)

This is the official Avaya website. The front page also provides access to individual Avaya websites for different regions and countries.

- [Avaya Sales & Partner Portal](#) (<https://sales.avaya.com>)

This is the official website for all Avaya business partners. The site requires registration for a user name and password. Once accessed, the portal can be customized for specific products and information types that you wish to see and be notified about by email.

- [Avaya IP Office Knowledgebase](#) (<https://ipofficekb.avaya.com>)

This site provides access to an online, regularly updated version of IP Office user guides and technical manual.

- [Avaya Support](#) (<https://support.avaya.com>)

This site provide access to Avaya product software, documentation and other services for Avaya product installers and maintainers.

- [Avaya Support Forums](https://support.avaya.com/forums/index.php) (<https://support.avaya.com/forums/index.php>)

This site provides a number of forums for discussing issues.

- [International Avaya User Group](https://www.iuag.org) (<https://www.iuag.org>)

This is the organization for Avaya customers. It provides discussion groups and forums.

- [Avaya DevConnect](https://www.devconnectprogram.com/) (<https://www.devconnectprogram.com/>)

This site provides details on APIs and SDKs for Avaya products, including IP Office. The site also provides application notes for 3rd-party non-Avaya products that interoperate with IP Office using those APIs and SDKs.

- [Avaya Learning](https://www.avaya-learning.com/) (<https://www.avaya-learning.com/>)

This site provides access to training courses and accreditation programs for Avaya products.

Related links

[Additional Help and Documentation](#) on page 116

Training

Avaya training and credentials are designed to ensure our Business Partners have the capabilities and skills to successfully sell, implement, and support Avaya solutions and exceed customer expectations. The following credentials are available:

- Avaya Certified Sales Specialist (APSS)
- Avaya Implementation Professional Specialist (AIPS)
- Avaya Certified Support Specialist (ACSS)

Credential maps are available on the [Avaya Learning](#) website.

Related links

[Additional Help and Documentation](#) on page 116

Index

Special Characters

_enable	
system SRTP	92

Numerics

46xxspecials.txt	29
------------------------	--------------------

A

activating	
scope	91
adding	
242 option	90
identity certificate	96
additional phone	
settings	28
adjusting	
diffserv QoS	38
Admin	
Static	101
administrative options	
1600 series	102
9600 series	102
Administrator	116
administrator process	
password	103
alternate	
options	86
APIs	117
application file	
upgrading	113
Application Notes	117
auto-generation	14

B

backup	
settings	64
blocking	
default passcodes	27
boot file	
upgrading	113
business partner locator	117

C

change	
craft password	96
changing	
file server settings	44

changing (<i>continued</i>)	
system SSON settings	41
channels	18
checking	
DHCP server support	88
TLS operation	99
clearing	
1600 series phones	109
9600 series phones	109
phone	109
configuring	
apache server	68
file	30
IIS server	67
IP phone	79
IPO system	75
VPN remote	79
connecting	
phone	55
control	
unit memory cards	24
control unit	
memory card	26
correct boot file	
application file	114
courses	117
creating	
setting file	45
customer network	
configuration	74
customizing	
operation	63

D

default	
extension password	51
DHCP	
Alternate server setup	86
settings	40
direct media	94
disabling	
SRTP	93
disabling on	
extension	93
line	93
downloading	
identity certificate	97
downloading from	
linux based server	97

Index

E

editing	
file	30
setting file	45
enabling	
9600 series	104
H.323 gatekeeper	36
hub interface	103, 104
RTCP quality monitoring	59
system quality reporting	60
system SRTP	93
telephone quality reporting	59
TLS on IPO	98
TLS on telephone	98
entering	
administrative options	102
example	
file	66
example setup	
overview	81
example system	
overview	84

F

file	
auto-generation	25
server	23
server settings	43
file server settings	45
forums	117

H

Help	116
HTTP	
authentication	65

I

installation	32
requirements	15
installing	
1600 series phones	70
9600 series phones	71
static address	70, 71
introduction	10
IP500	
control unit	48

L

license	
subscriptions	17, 34
listing	

listing (<i>continued</i>)	
registered phones	57
loading	
files	50
software files	47
loading files	
third party server	50

M

manual	
backup	66
manually	
copying files	49
creating extensions	52
editing file	47
Manuals	116

N

network	
assessment	17
nouser	
source	30

P

pc	
connection	21
phone	
configuration	76
file requests	25
firmware	12
potential	
VoIP	20
power	
supply	22
problems	20

Q

QoS	20
Quick Reference Guides	116

R

registering	
phone	56
registration	
blacklisting	26
remote	73
Reseller	116
reserving	
licenses	34
resetting	
1600 series phone	108

resetting (*continued*)

- 9600 series phone [108](#)
- phone [107](#)

restart [112](#)

restore

- control [66](#)
- settings [64](#)

S

sales [117](#)

scope [88](#)

screen saver

- settings [63](#)

screensaver [62](#)

SDKs [117](#)

selecting

- codec [53](#)

self-test procedure

- 1600 series phones [106](#)
- 9600 series phones [107](#)

server

- options [23](#)

setting

- quality alarm levels [61](#)
- RTP port range [36](#)

settings

- screen saver [63](#)

simple

- installation [14](#)

site specific

- option number [110](#)

source

- numbers [30](#)

specifying

- BRURI value [65](#)

S RTP [92](#)

SSON

- 1600 series phones [110](#)
- 9600 phone series [111](#)

static address

- installation [70](#)
- settings [71, 72](#)

Static administration [101](#)

supply

- options [22](#)

support [117](#)

supported

- IP phones [11](#)
- VPN remote phone [78](#)

system

- capacity [12](#)
- default codecs [38](#)
- DHCP support [40](#)

System Administrator [116](#)

system site

- specific option numbers [41](#)

T

Technical Bulletins [117](#)

TLS [95](#)

training [117, 118](#)

U

uploading

- certificate [97](#)

user

- extension creation [51](#)
- pc [21](#)

User Guides [116](#)

using

- auto creation [54](#)
- static administration options [101](#)

using embedded file manager

- upload files [48](#)

V

view details

- 1600 series phones [105](#)
- phones [104](#)

viewing details

- 9600 series phones [106](#)

VLAN

- DHCP [80](#)
- IP Phones [79](#)

voice

- compression [18](#)

VPN

- remote phones [77](#)

W

websites [117](#)