



AVAYA



Avaya Gemini Analog 9330-AV





CONTENTS

User guide	4
Guide utilisateur	8
Bedienungsanleitung	12
Guía de usuario	16
Guida per l'uso	20





Figure one
Figure un
Abbildung Eins
Figura uno

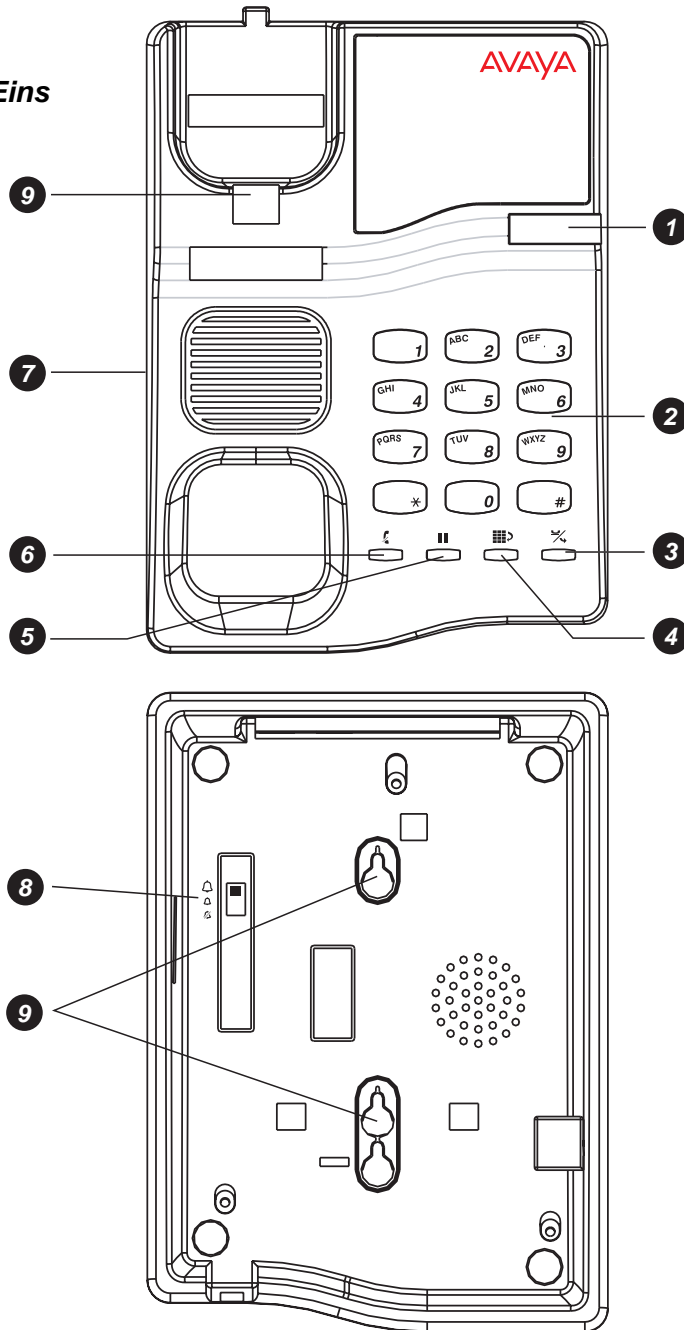

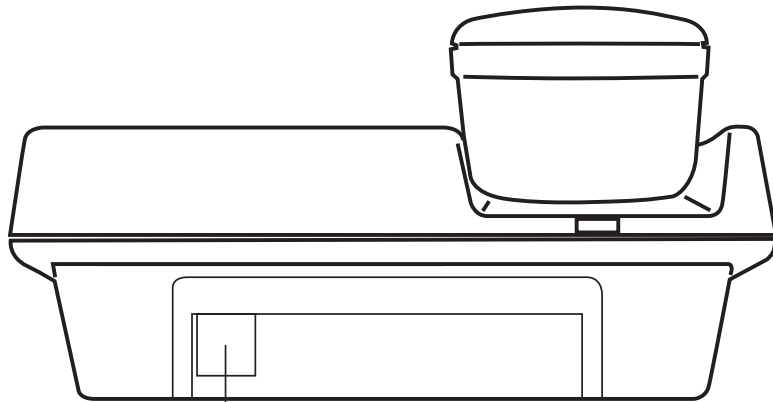









10

GB

The Avaya Gemini Analog telephone is designed to work behind the Avaya IP OFFICE telephone system.

Telephone Features

Please refer to **figure one** at the front of this user guide.

- 1**  The red message waiting light flashes when you have a message. It also flashes when your telephone rings.
- 2**  A standard telephone keypad with the number "5" having a raised dot for visually impaired users.
- 3**  Press this key during a call to return dial tone. This will enable you to transfer the call to another party or instigate a feature such as conference.
- 4**  Press this key to redial the last number you dialled from the keypad.
- 5**  Press this key to insert a pause.
- 6**  This key mutes the microphone so the other person on the call cannot hear you. A red lamp indicates the mute is on. Pressing it a second time releases the mute and returns you to normal conversation.
- 7**  The handset cord plugs in here.
- 8**  A 3-position switch to control the volume of the ring tone. Select from loud ring, quiet ring or ringer off.
- 9**  Wall mounting – Using the template supplied, position where you want to fix your telephone. Drill two holes and fix roundhead screws, slide the telephone into place. Remove the handset retainer by pushing up out of the slot. Turn the retainer through 180° and place back in its slot.



10



This jack is used to connect a line cord to your telephone.

Declaration of Conformity

Avaya declares that this product Avaya Gemini Analog telephone 9330-AV is in conformity with the following harmonised standards:

Health Safety	EN 60950 : 1992
Electromagnetic Compatibility	EN 55022 : 1998 & EN 55024 : 1998
Telecom	TBR21 : 1998 & TBR38 : 1998

Following the provisions of the Council Directive on radio and telecommunications terminal equipment.

July 2003.

Intended use

The Avaya Gemini Analog telephone has *only* Touch-tone Dialling(DTMF). This telephone also supports Timed-break recall, no special settings are needed to engage these features.

The telephone has been designed to work behind the Avaya IP OFFICE telephone system.

Because the product is connected behind a PABX it must not be relied upon to con-



tact the emergency services during a power failure.

Safety

When using your telephone equipment, the following safety precautions should always be followed to reduce the risk of fire, electric shock and injury to persons.

Read and understand all instructions

Follow all warnings and instructions marked on the telephone.

This telephone can be hazardous if immersed in water.

Avoid using the telephone during thunderstorms in your immediate area

If you suspect a natural gas leak, report it immediately, but use a telephone away from the area in question.

Never push objects of any kind into the equipment through housing slots.

To reduce the risk of electric shock, do not disassemble this telephone. There are no user serviceable parts.

Service

Before cleaning, unplug the telephone from the modular wall jack. Do not use liquid cleaners or aerosol cleaners. Use a damp cloth for cleaning.

Hearing Aid Compatible

This telephone is Hearing Aid Compatible (HAC)

Warranty

This product is guaranteed for 18 months from the date of manufacture. To get warranty service on your telephone call the authorised service agent on +44 870 220 0402 Alternatively you may call the distributor from whom the product was purchased.

If you are directed to ship your telephone to the authorised service location, you must do this at your cost. We suggest that you retain the original packing material in the event you need to ship the unit. When sending your telephone include your name,



address, and phone number, and description of the fault. After repairing or replacing your telephone, it will be shipped back at our expense.



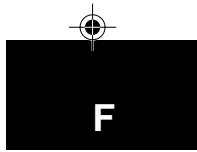









Le téléphone analogique Avaya Gemini a été conçu pour fonctionner avec l'autocommutateur IP OFFICE de la société Avaya.

Fonctions et caractéristiques

Veillez vous reporter à la **Figure 1** au début de ce guide.

- 1**  Le voyant rouge d'indication de message clignote pour signaler la présence d'un message. Il clignote également lorsque le téléphone sonne.
- 2**  Clavier téléphonique standard avec un point en relief sur le chiffre "5" à l'attention des malvoyants.
- 3**  Appuyez sur cette touche pendant un appel pour récupérer la tonalité. Ceci vous permet de transférer l'appel ou de sélectionner une option, comme par exemple la conférence.
- 4**  Appuyez sur cette touche pour rappeler le dernier numéro composé.
- 5**  Appuyez sur cette touche pour insérer une pause.
- 6**  Appuyez sur cette touche pour couper le microphone et ne plus être entendu par votre correspondant. Un voyant rouge signale que le microphone a été coupé. Pour le réactiver, appuyez à nouveau sur cette touche.
- 7**  Emplacement réservé au raccordement du combiné.
- 8**  Interrupteur à trois positions pour le contrôle du volume de la sonnerie. Les trois positions sont les suivantes : sonnerie forte, sonnerie faible ou sonnerie coupée.
- 9**  Montage mural – A l'aide du gabarit fourni, repérez l'emplacement où vous souhaitez installer le téléphone. Percez deux trous et insérez des vis à tête ronde. Mettez en place le téléphone en le faisant coulisser. Extraire de la fente le système de retenue du combiné en poussant vers le haut. Retournez

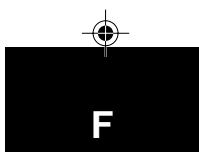

de 180° le système de retenue du combiné et replacez-le dans la fente.

10



Prise pour le raccordement de la ligne téléphonique.

Déclaration de conformité

Avaya déclare que le téléphone analogique « Avaya Gemini 9330-AV », respecte les normes harmonisées suivantes :

Health Safety	EN 60950 : 1992
Electromagnetic Compatibility	EN 55022 : 1998 & EN 55024 : 1998
Telecom	TBR21 : 1998 & TBR38 : 1998

Suivant les dispositions de la Directive du Conseil sur les équipements terminaux de radio et de télécommunications.

Juillet 2003.

Consignes d'utilisation

Le téléphone analogique Avaya Gemini dispose d'une numérotation à fréquences vocales (DTMF). Il supporte également la fonction de rappel d'enregistreur. Aucun réglage particulier n'est nécessaire pour utiliser ces options.

Le téléphone a été conçu pour fonctionner avec l'autocommutateur IP OFFICE de la société Avaya.

Etant donné que le téléphone est connecté derrière un autocommutateur, il risque de ne pas fonctionner correctement en cas de panne de courant, ce qui rendra impossible tout appel aux services d'urgence.



Consignes de sécurité

Vous éviterez tout risque d'incendie, de décharge électrique ou de blessure en respectant scrupuleusement les consignes de sécurité énoncées ci-dessous.

Assurez-vous de bien comprendre les instructions fournies.

Respectez les avertissements et consignes figurant sur le téléphone.

Ce téléphone peut être dangereux en cas d'immersion dans l'eau.

Évitez de vous servir du téléphone pendant un orage.

Toute fuite de gaz doit être signalée sans délai à l'aide d'un poste téléphonique suffisamment éloigné de la zone en question.

N'introduisez jamais rien dans les ouvertures du boîtier.

Ne démontez ce téléphone sous aucun prétexte. Vous vous exposeriez à des tensions dangereuses et vous risqueriez de ne pouvoir le remettre dans son état initial. Vous ne pouvez en aucun cas le réparer vous-même.

Entretien

Pour nettoyer le téléphone, débranchez-le. N'employez aucun produit d'entretien (liquide, aérosol) mais utilisez un chiffon doux légèrement humide.

Compatibilité avec les prothèses auditives

Ce téléphone est compatible avec les prothèses auditives (HAC – Hearing Aid Compatible).

Garantie

Ce produit est garanti pendant 18 mois à compter de sa date de fabrication. Pour bénéficier de cette garantie, veuillez contacter l'agent après-vente agréé au : +44 870 220 0402 ou bien le distributeur.

Les frais d'envoi du téléphone au service après-vente agréé sont à votre charge. Par conséquent, nous vous recommandons de conserver son emballage d'origine pour

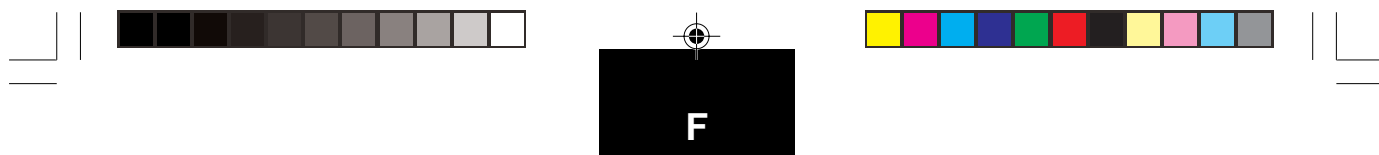

utilisation lors du transport. Avant toute expédition, veuillez indiquer vos nom, adresse et numéro de téléphone, ainsi qu'une description de la panne. Après réparation ou remplacement, l'appareil vous sera retourné à nos frais.



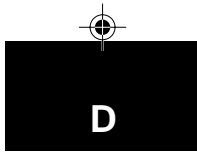









Das Avaya Gemini Analogtelefon wurde für die Avaya IP OFFICE Kommunikationssysteme entworfen.

Eigenschaften des Telefons

Siehe **Abbildung Eins** vorne in dieser Bedienungsanleitung.

1		Das rote 'Nachricht wartet'-Licht blinkt, wenn Sie eine Nachricht erhalten haben. Es blinkt außerdem, wenn Ihr Telefon klingelt.
2		Eine Standard-Telefontastatur. Auf der Nummer '5' befindet sich ein erhöhter Punkt für Benutzer mit Sehbehinderungen.
3		Wenn Sie diese Taste während eines Gesprächs drücken, kehren Sie zum Wählton zurück. So können Sie Anrufe an Dritte weiterleiten oder Eigenschaften wie Konferenzgespräche initiieren.
4		Wenn Sie diese Taste drücken, wird automatisch die letzte von Ihnen ausgewählte Nummer wieder gewählt. (Wahlwiederholung)
5		Betätigen Sie diesen Schlüssel, um eine Pause einzusetzen.
6		Diese Taste schaltet das Mikrofon stumm, so dass Sie von der anderen Person nicht gehört werden können. Ein rotes Licht zeigt diese Stummschaltung an. Wenn Sie die Taste ein zweites Mal drücken, wird die Stummschaltung aufgehoben und Sie können mit Ihrem Gespräch fortfahren.
7		Hier wird das Hörerkabel eingesteckt.
8		Ein Schalter mit drei Positionen zur Lautstärkeregelung des Klingeltons. Sie können lautes und leises Klingeln einstellen bzw. den Klingelton abstellen.

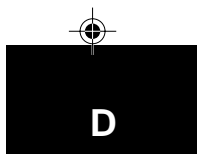
**9**

Wandaufhängung – Wählen Sie mit Hilfe der beiliegenden Vorlage die Position Ihres Telefons an der Wand. Bohren Sie zwei Löcher, passen Sie zwei Halbrundschrauben ein und schieben Sie das Telefon darauf. Entfernen Sie die Hörerhalterung, indem Sie sie nach oben aus dem Schlitz ziehen. Drehen Sie die Halterung um 180° und schieben Sie sie in den Schlitz zurück.

10

An dieser Buchse wird Ihr Anschlußkabel an Ihr Telefon angeschlossen.

Konformitätserklärung

Avaya erklärt hiermit, dass das Produkt Avaya Analog -Telefon Gemini 9330-AV mit folgenden harmonisierten Normen konform ist:

Health Safety	EN 60950 : 1992
Electromagnetic Compatibility	EN 55022 : 1998 und EN 55024 : 1998
Telecom	TBR21 : 1998 und TBR38 : 1998

Gemäß den Vorgaben der Ratsrichtlinie zu Radio- und Telekommunikationsstationsgeräten.

Juli 2003.

Verwendungszweck

Das Avaya Gemini Analog-Telefon verfügt nur über DTMF-Wahl (Mehrfrequenz-Tonwahl). Dieses Telefon unterstützt außerdem Anrufwiederholung. Zum Einschalten dieser Eigenschaften ist keine spezielle Einstellung erforderlich.

Das Telefon wurde für die Avaya IP OFFICE Kommunikationssysteme entworfen.

Da das Produkt an eine Nebenstellenanlage angeschlossen ist, sollte man bei einem Stromausfall nicht davon ausgehen, die Rettungsdienste 110 / 112 erreichen zu können.

Sicherheit

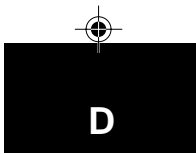

Befolgen Sie bei der Verwendung Ihrer Telefongeräte stets die folgenden Sicherheitsvorkehrungen, um das Risiko von Bränden, Stromschlägen und Körperverletzungen zu reduzieren.

Lesen und beachten Sie alle Anweisungen.

Befolgen Sie alle Warnhinweise und Anweisungen auf dem Telefon.

Dieses Telefon kann bei Eintauchen in Wasser gefährlich sein.

Vermeiden Sie die Verwendung des Telefons bei Gewittern in Ihrer unmittelbaren Nähe.

Wenn Sie einen Erdgasaustritt vermuten, melden Sie dies sofort, verwenden Sie dazu jedoch ein Telefon, das sich nicht im fraglichen Bereich befindet.

Schieben Sie nie Gegenstände irgendwelcher Art durch die Schlitze im Gehäuse in das Gerät.

Um das Risiko eines Stromschlags zu reduzieren, nehmen Sie das Telefon nicht auseinander. Es enthält keine Teile, die vom Benutzer gewartet werden können.

Pflege

Entfernen Sie vor der Reinigung des Telefons bitte das Anschlußkabel. Bitte verwenden Sie keine Flüssig- oder Sprühreiniger. Reinigen Sie das Gerät mit einem feuchten Tuch.

Kompatibilität mit Hörgeräten

Dieses Telefon ist mit Hörgeräten kompatibel.

Garantie

Dieses Produkt besitzt eine Garantie von 18 Monaten ab Herstellungsdatum. Wenn Sie einen Kundendienst Ihres Telefons im Rahmen der Garantie wünschen, wenden Sie sich bitte unter +44 870 220 0402 an den offiziellen Kundendienstvertreter.

Alternativ hierzu, können Sie sich an den Händler wenden, von dem Sie das Telefon

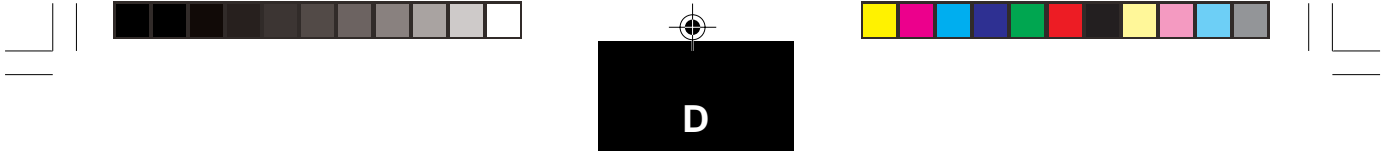

erworben haben.

Falls Sie angewiesen werden, Ihr Telefon an die offizielle Kundendienstvertretung zu senden, hat dies auf Ihre Kosten zu erfolgen. Wir empfehlen, die Originalverpackung für diesen Fall aufzuheben. Wenn Sie das Telefon abschicken, legen Sie bitte Ihren Namen, Adresse und Telefonnummer sowie eine Fehlerbeschreibung bei. Das reparierte bzw. ersetzte Telefon wird auf unsere Kosten an Sie zurück geschickt.



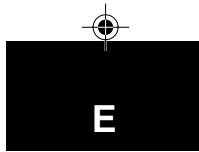









El teléfono Avaya Gemini Analog está diseñado para funcionar junto con el sistema Avaya IP OFFICE.

Funciones del Teléfono

Por favor remítase a la **figura uno** en la parte delantera de esta guía de usuario.

1		La lámpara roja de mensaje en espera parpadea cuando usted tiene un mensaje. También parpadea cuando suena su teléfono.
2		Teclado numérico de telefónico estándar incluyendo en el número "5" un punto en relieve para los usuarios con problemas de visión.
3		Pulse esta tecla durante una llamada para volver al tono de marcar. Esto le permitirá transmitir la llamada a un tercero u originar una función como la de conferencia
4		Pulse para volver a marcar el último número que usted marcó desde el teclado numérico.
5		Presione esta llave para insertar una pausa.
6		Esta tecla suprime su micrófono de forma que la otra persona en la llamada no pueda oírle. Una lámpara roja indica que la supresión de sonido está activada. Pulsándola una segunda vez se elimina la supresión de sonido y se le devuelve a una conversación normal.
7		El cable del microteléfono se enchufa aquí.
8		Interruptor de 3 posiciones para controlar el volumen del tono de timbre. Seleccione entre timbre fuerte, timbre bajo o timbre desactivado.

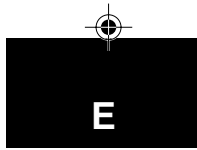
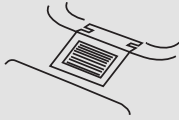
**9**

Montaje en pared – Utilizando la plantilla suministrada, determine dónde quiere fijar su teléfono. Haga dos agujeros con el taladro y fije los tornillos de cabeza redonda; deslice el teléfono en su lugar. Extraiga el retén del microteléfono sacándolo de la ranura empujándolo hacia arriba. Haga girar el retén 180° y vuelva a colocarlo en su ranura.

10

Este jack se utiliza para conectar un cable de línea a su teléfono.

Declaración de Conformidad

Avaya declara que este producto de teléfono Avaya Gemini Analog 9330-AV es conforme con las siguientes normas armonizadas:

Health Safety	EN 60950 : 1992
Electromagnetic Compatibility	EN 55022 : 1998 y EN 55024 : 1998
Telecom	TBR21 : 1998 y TBR38 : 1998

Siguiendo las disposiciones de la Directiva del Consejo sobre equipos terminales de telecomunicaciones y radio.

Julio 2003.

Uso pretendido

El teléfono Avaya Gemini Analog *solamente* tiene Marcación Multifrecuencia (DTMF). Este teléfono también soporta rellamada; no se precisa ningún ajuste especial para incorporar estas funciones.

El teléfono ha sido diseñado para funcionar junto con el sistema Avaya IP OFFICE.

Dado que el producto está conectado con una centralita, en caso de fallo en el suministro eléctrico este teléfono no proporcionará tono de marcado por lo que no podría utilizarse para contactar servicios de emergencia.

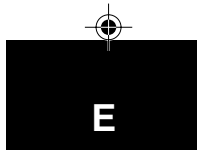

Seguridad

Al utilizar su teléfono, siempre deber tener en cuenta las siguientes precauciones de seguridad para reducir el riesgo de incendio, descarga eléctrica o heridas a las personas.

Lea y entienda todas las instrucciones.

Tenga en cuenta todas las advertencias e instrucciones indicadas en el teléfono.

Este teléfono puede ser peligroso si se sumerge en agua.

Evite utilizar el teléfono durante el transcurso de tormentas eléctricas en su zona más próxima.

Si usted sospecha que existe una fuga de gas natural, informe de ello inmediatamente, pero utilice un teléfono alejado de la zona en cuestión.

Nunca introduzca objetos de ningún tipo en el equipo a través de las ranuras de la caja.

Para reducir el riesgo de descarga eléctrica, no desmonte este teléfono. No hay ninguna pieza accesible o reemplazable por el usuario.

Servicio

Antes de llevar a cabo la limpieza, desenchufe el teléfono de la roseta. No utilice limpiadores líquidos o limpiadores de aerosol. Utilice un paño húmedo para la limpieza.

Compatible con Audífono

Este teléfono es Compatible con Audífono (HAC)

Garantía

Este producto tiene garantía de 18 meses desde la fecha de fabricación. Para obtener el servicio de garantía en su teléfono, llame al agente de servicio autorizado al número +44 870 220 0402. También puede llamar al distribuidor que le vendió el producto.

En caso de tener que enviar su teléfono a reparar, debe hacerlo corriendo con los

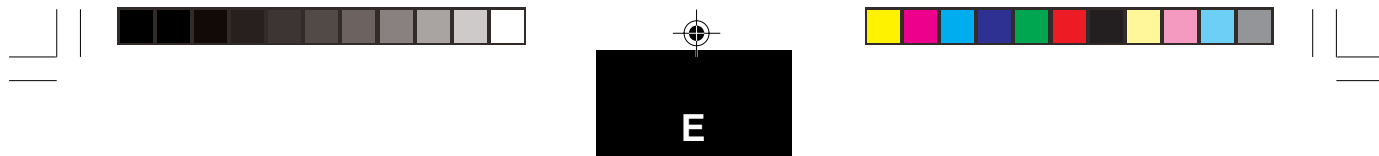









gastos. Le sugerimos que conserve el material de embalaje original por si tiene que enviar la unidad. Cuando envíe su teléfono incluya su nombre, dirección y número de teléfono, y la descripción de lo que falla. Tras reparar o cambiar su teléfono, se lo enviaremos asumiendo nosotros los gastos.



Il telefono Avaya Gemini Analog è studiato per funzionare dietro un sistema telefonico Avaya IP OFFICE.

Funzionalità del telefono

Vedere la **figura uno** sulla parte anteriore di questa guida per l'uso.

- 1**  La spia rossa di attesa messaggio lampeggia quando avete un messaggio. Lampeggia anche quando squilla il telefono.
- 2**  Un tastierino telefonico standard con il numero "5" dotato di punto rialzato per gli utenti non vedenti.
- 3**  Premete questo tasto durante una chiamata per ripristinare il tono di chiamata. Questo vi permette di trasferire la chiamata ad un altro utente o di attivare una funzionalità, tipo conferenza.
- 4**  Premete per ricomporre l'ultimo numero composto dal tastierino.
- 5**  Premi questa chiave per inserire una pausa.
- 6**  Questo tasto silenzia il microfono così che l'altra persona non possa sentirvi. Una spia rossa indica che la funzione è abilitata. Premendo il tasto una seconda volta disabilitate la funzione e ritornate alla conversazione normale.
- 7**  Il filo del ricevitore viene inserito qui.
- 8**  Un interruttore a 3 posizioni per controllare il volume della suoneria. Selezionate fra suono forte, silenzioso o disabilitato.
- 9**  Montaggio a muro – Usando la sagoma fornita, montatelo nella posizione preferita. Eseguite due fori e fissate con viti a testa rotonda, facendo scivolare il telefono in posizione. Rimuovete il fermo del ricevitore spingendolo dalla scanalatura. Girate il fermo di 180° e rimettetelo nella relativa scanalatura.

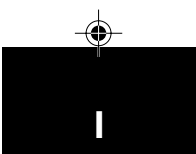
**10**

Questo spinotto viene utilizzato per il collegamento di un cavo di linea al telefono.

Dichiarazione di conformità

Avaya dichiara che questo prodotto Avaya Gemini Analog telefono 9330-AV è conforme alle seguenti normative armonizzate:

Health Safety	EN 60950 : 1992
Electromagnetic Compatibility	EN 55022 : 1998 e EN 55024 : 1998
Telecom	TBR21 : 1998 e TBR38 : 1998

Secondo le disposizioni della Direttiva del Consiglio sulle apparecchiature terminali radio e telecomunicazioni.

Luglio 2003.

Uso preposto

Il telefono Avaya Gemini Analog è dotato solo di toni a multifrequenza (DTMF) e supporta anche la funzione di richiamata dell'ultimo numero. Non sono richieste configurazioni speciali per abilitare queste funzionalità.

Il telefono è progettato per funzionare con il sistema telefonico Avaya IP OFFICE.

Poiché è collegato dietro un PABX non fare affidamento sul prodotto per il contatto con i servizi d'emergenza nei periodi di mancanza di alimentazione elettrica.

Sicurezza

Quando utilizzate il vostro apparecchio telefonico, seguite sempre le seguenti precauzioni di sicurezza per ridurre il rischio di incendio, scossa elettrica o lesioni personali.

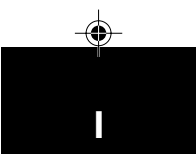

Leggete attentamente tutte le istruzioni

Seguite tutte le avvertenze e le istruzioni apposte sul telefono.

Questo telefono può essere pericoloso se immerso nell'acqua.

Non utilizzare il telefono durante i temporali nell'area immediatamente vicina a voi.

Se sospettare una perdita di gas naturale, denunciatela immediatamente, ma utilizzate un telefono lontano dall'area interessata.

Non inserite mai oggetti di alcun tipo dentro l'apparecchio attraverso le scanalature di alloggiamento.

Per ridurre il rischio di scossa elettrica, non smontate il telefono. Il telefono non contiene parti che richiedono la manutenzione da parte dell'utente.

Manutenzione

Prima di pulirlo, staccate la spina del telefono dalla presa a muro. Non usate detergenti liquidi o aerosol. Usate un panno umido per pulire il telefono.

Compatibile con auricolari per i non udenti

Questo telefono è compatibile con l'uso degli auricolari per i non udenti

Garanzia

Questo prodotto è garantito per 18 mesi dalla data di fabbricazione. Per ottenere la manutenzione in garanzia sul telefono telefonate all'agente autorizzato alla manutenzione al numero +44 870 220 0402, o telefonate al distributore presso il quale avete acquistato il prodotto.

Se vi viene chiesto di spedire il telefono alla sede di manutenzione autorizzata, dovete farlo a vostre spese. Vi suggeriamo di conservare il materiale di imballaggio originale nel caso dobbiate spedire l'unità. Quando spedite il telefono, includete il vostro nome, cognome, indirizzo, numero di telefono e la descrizione del guasto. Dopo la riparazione o sostituzione del telefono, l'apparecchio vi sarà rispedito a nostre spese.



3C933001-AV

